

40V N-Channel Enhancement Mode MOSFET

1. Product Information

1.1 Features

- ◇ Advanced SGT cell design
- ◇ Surface-mounted package
- ◇ Low Thermal Resistance

1.2 Applications

- ◇ Motor drivers
- ◇ DC - DC Converter

1.3 Quick reference

- ◇ $BV \cong 40\text{ V}$
- ◇ $P_{\text{tot}} \cong 250\text{ W}$
- ◇ $I_D \cong 300\text{ A}$
- ◇ $R_{\text{DS(ON)}} \cong 0.68\text{ m}\Omega @ V_{\text{GS}} = 10\text{ V}$
- ◇ $R_{\text{DS(ON)}} \cong 1.39\text{ m}\Omega @ V_{\text{GS}} = 4.5\text{ V}$

2. Pin Description

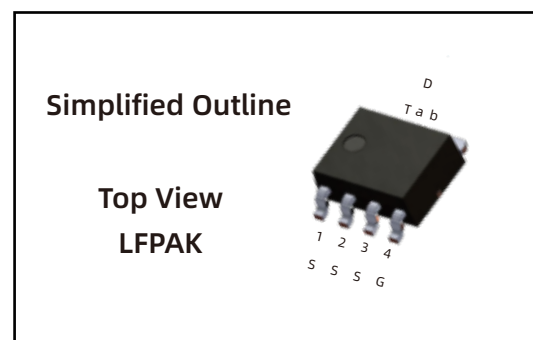
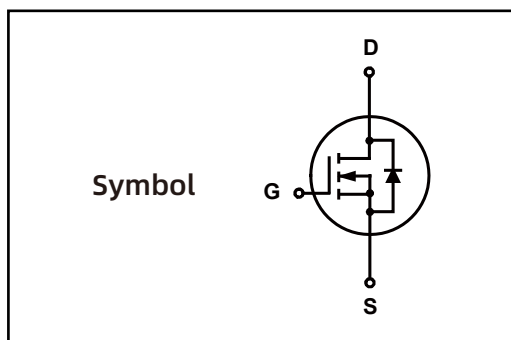

3. Marking Information

Product Name	Marking
LN007N040LF-L	LN007N040LF-L CYWWZZ XXXXXX

4. Limiting Values

Symbol	Parameter	Conditions	Min	Max	Unit
V_{DS}	Drain-Source Voltage	$T_C = 25\text{ }^\circ\text{C}$	-	40	V
V_{GS}	Gate-Source Voltage	$T_C = 25\text{ }^\circ\text{C}$	-	± 20	V
$I_D^{*,***}$	Drain Current	$T_C = 25\text{ }^\circ\text{C}, V_{GS} = 10\text{ V}$	-	300	A
		$T_C = 100\text{ }^\circ\text{C}, V_{GS} = 10\text{ V}$	-	281	A
$I_{DM}^{*,**}$	Pulsed Source Current	$T_C = 25\text{ }^\circ\text{C}, V_{GS} = 10\text{ V}$	-	1200	A
P_{tot}^*	Total power dissipation	$T_C = 25\text{ }^\circ\text{C}$	-	250	W
T_{stg}	Storage Temperature		- 55	175	$^\circ\text{C}$
T_J	Junction Temperature		-	175	$^\circ\text{C}$
I_S	Diode Forward Current	$T_C = 25\text{ }^\circ\text{C}$	-	300	A
E_{AS}^*	Single Pulsed Avalanche Energy	$V_{DD} = 50\text{ V}, L = 1.0\text{ mH}$	-	800	mJ
$R_{\theta JA}^*$	Thermal Resistance- Junction to Ambient		-	60	$^\circ\text{C/W}$
$R_{\theta JC}^*$	Thermal Resistance- Junction to Case		-	0.6	

Notes :

- * Surface Mounted on 1 in² pad area, $t \leq 10\text{ sec}$
- ** Pulse width $\leq 300\text{ }\mu\text{s}$, duty cycle $\leq 2\%$
- *** Limited by bonding wire

5. Ordering Code

Product Name	Package	Reel Size	Tape width	Quantity	Note
LN007N040LF-L	LFPAK5*6	$\varnothing 330\text{mm}$	12mm	5000	

Note: COMTECH defines " Green " as lead-free (RoHS compliant) and halogen free (Br or Cl does not exceed 900 ppm by weight in homogeneous material and total of Br and Cl does not exceed 1500 ppm by weight; Follow IEC 61249-2-21 and IPC / JEDEC J-STD-020C)

6. Electrical Characteristics ($T_A=25^\circ$ Unless Otherwise Noted)

Symbol	Parameter	Conditions	Min	Typ	Max	Unit
Static Characteristics						
BV_{DSS}	Drain-Source Breakdown Voltage	$V_{GS} = 0\text{ V}, I_{DS} = 250\ \mu\text{A}$	40	-	-	V
$V_{GS(th)}$	Gate Threshold Voltage	$V_{DS} = V_{GS}, I_{DS} = 250\ \mu\text{A}$	1	-	2.5	V
I_{DSS}	Drain Leakage Current	$V_{DS} = 32\text{ V}, V_{GS} = 0\text{ V}$	-	-	1	μA
I_{GSS}	Gate Leakage Current	$V_{GS} = \pm 20\text{ V}, V_{DS} = 0\text{ V}$	-	-	± 100	nA
$R_{DS(on)}^a$	On-State Resistance	$V_{GS} = 10\text{ V}, I_{DS} = 30\text{ A}$	-	0.57	0.68	m Ω
		$V_{GS} = 4.5\text{ V}, I_{DS} = 20\text{ A}$	-	1.07	1.39	
Diode Characteristics						
V_{SD}^a	Diode Forward Voltage	$I_{SD} = 30\text{ A}, V_{GS} = 0\text{ V}$	-	-	1.3	V
t_{rr}	Reverse Recovery Time	$I_{DS} = 30\text{ A}, V_{GS} = 0\text{ V}$	-	71	-	nS
Q_{rr}	Reverse Recovery Charge	$di_{SD}/dt = 100\text{ A}/\mu\text{s}$	-	77	-	nC
Dynamic Characteristics^b						
C_{ISS}	Input Capacitance	$V_{GS} = 0\text{ V}, V_{DS} = 20\text{ V}$ Frequency = 1 MHz	-	5733	-	pF
C_{OSS}	Output Capacitance		-	2609	-	
C_{rSS}	Reverse Transfer Capacitance		-	154	-	
$t_d(on)$	Turn-on Delay Time	$V_{DS} = 20\text{ V}, V_{GEN} = 10\text{ V},$ $R_G = 3.9\ \Omega, R_L = 0.66\ \Omega,$ $I_{DS} = 30\text{ A}$	-	18	-	nS
t_r	Turn-on Rise Time		-	73	-	
$t_d(off)$	Turn-off Delay Time		-	102	-	
t_f	Turn-off Fall Time		-	70	-	
Gate Charge Characteristics^b						
Q_g	Total Gate Charge	$V_{GS} = 10\text{ V}, V_{DS} = 20\text{ V},$ $I_{DS} = 30\text{ A}$	-	111	-	nC
Q_{gs}	Gate-Source Charge		-	21	-	
Q_{gd}	Gate-Drain Charge		-	27	-	

Notes :

a : Pulse test ; pulse width $\leq 300\ \mu\text{s}$, duty cycle $\leq 2\%$

b : Guaranteed by design, not subject to production testing

7. Typical Characteristics

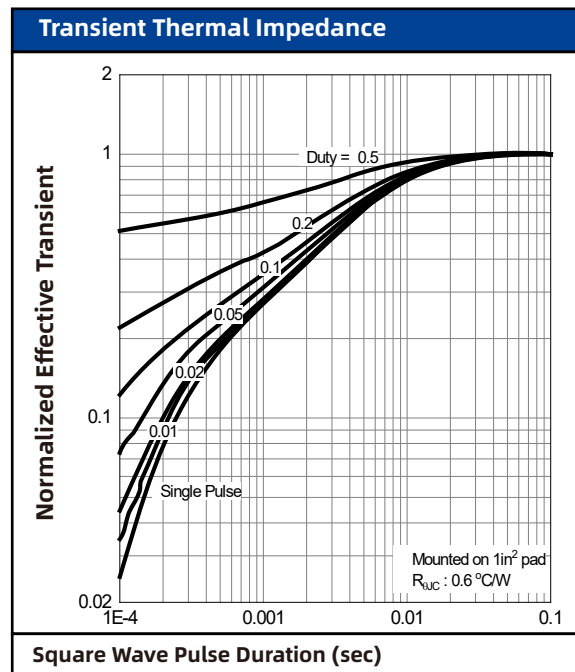
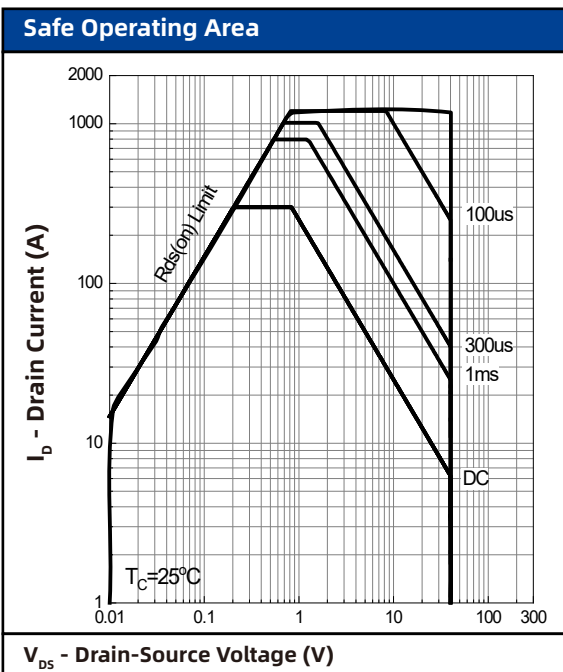
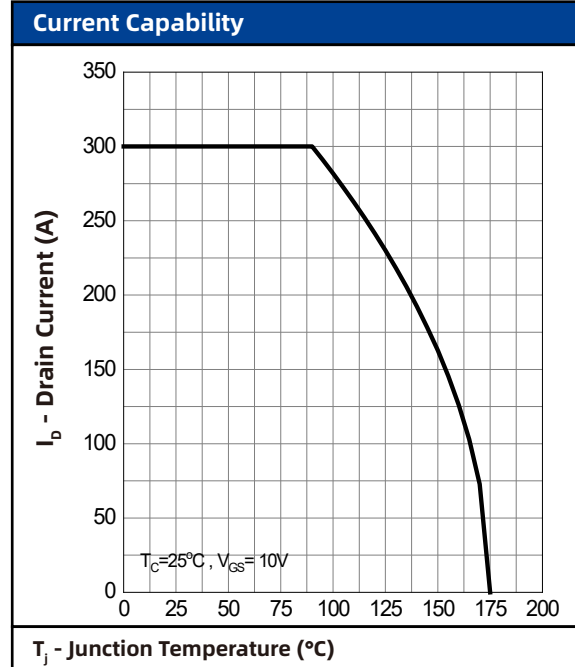
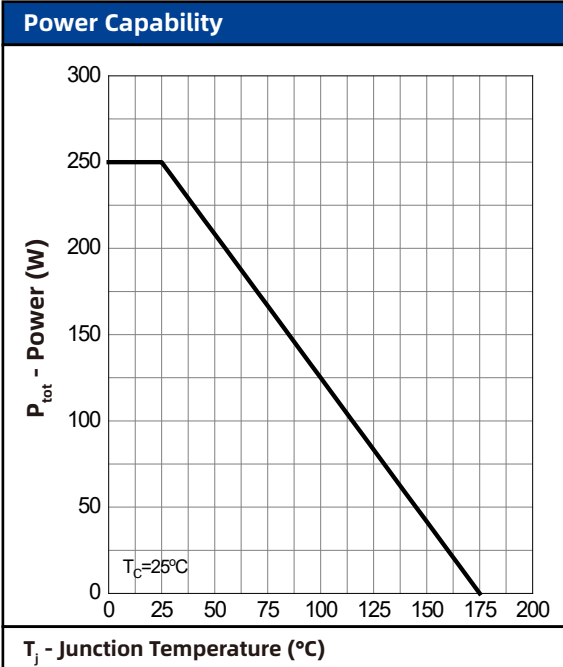

7. Typical Characteristics (cont.)

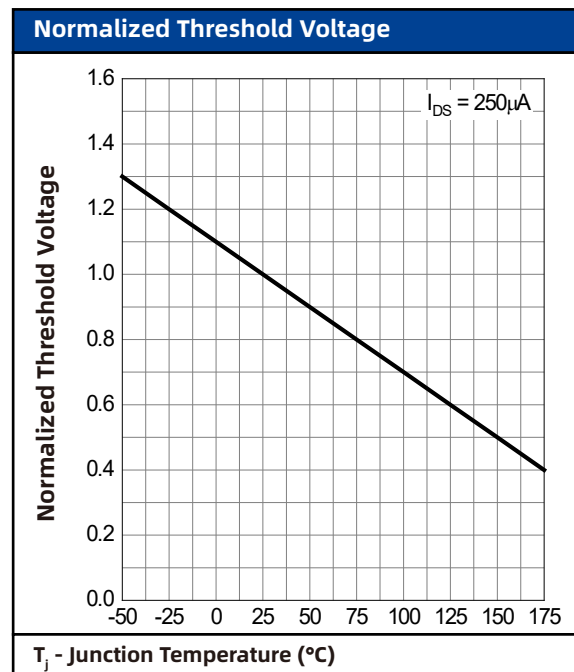
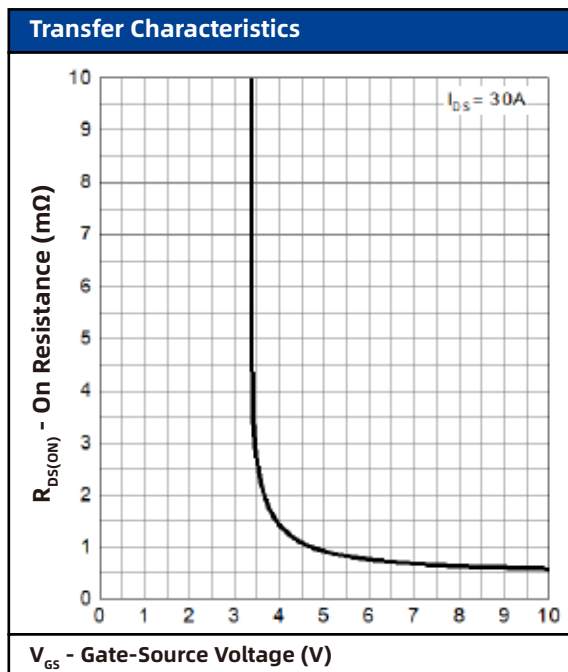
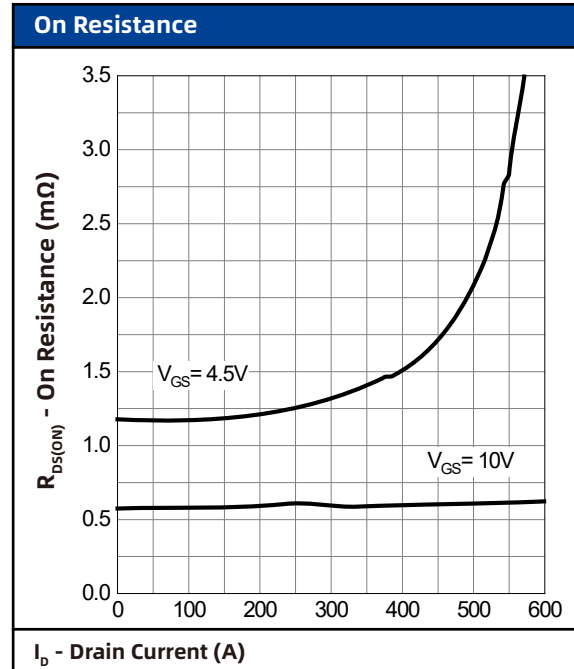
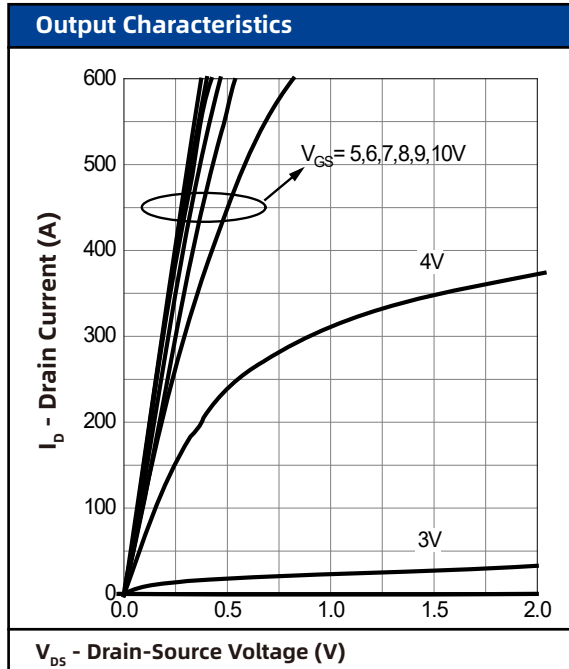

7. Typical Characteristics (cont.)

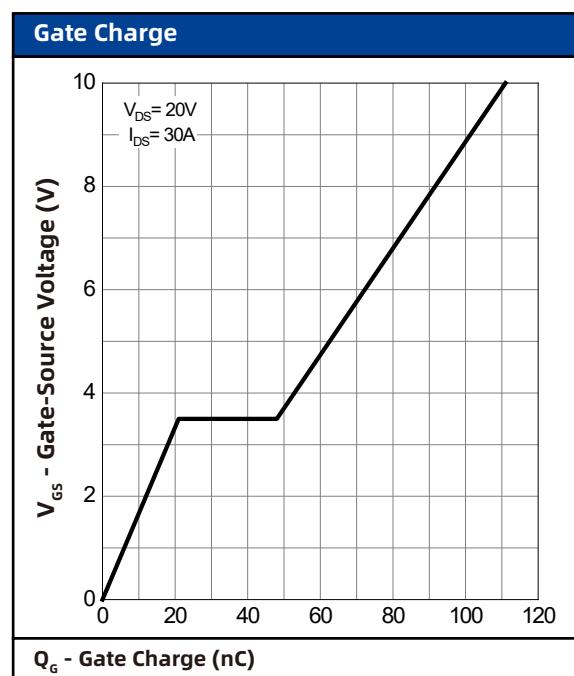
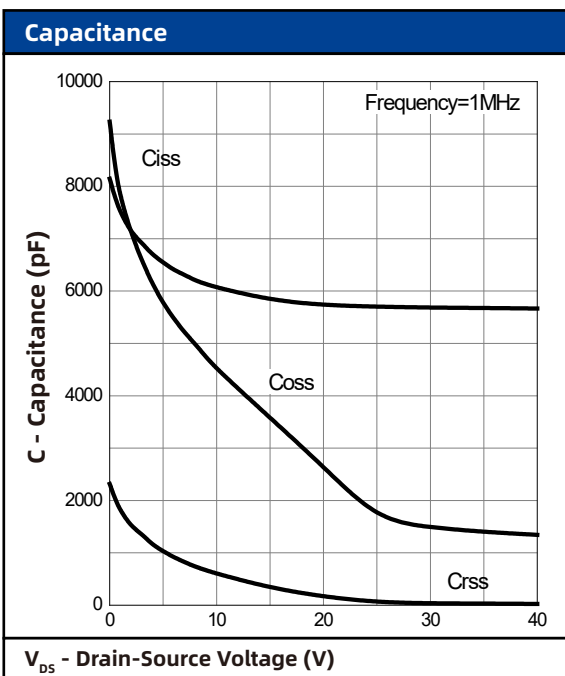
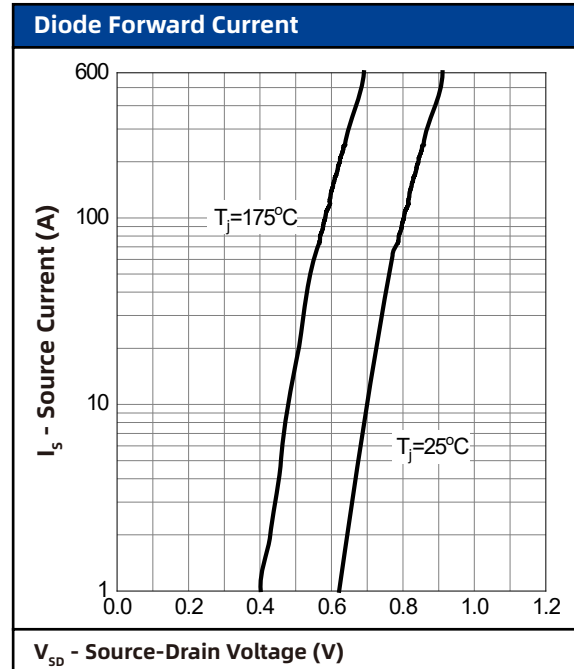
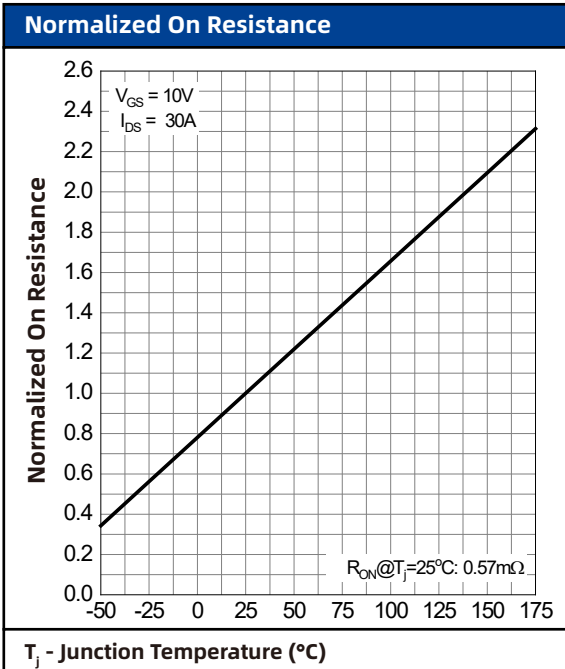

8. Package Dimensions

LFPAK5*6 Package

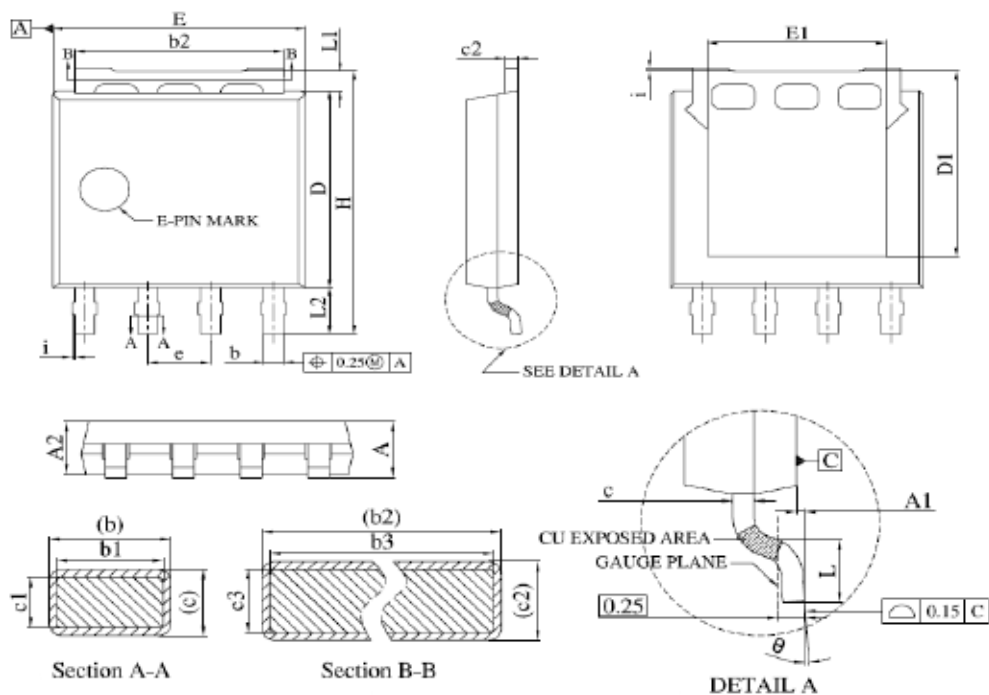

Symbol	Dimensions In Millimeters	
	Min.	Max.
A	1.00	1.30
A1	0.00	0.15
A2	0.98	1.12
b	0.35	0.50
b1	0.32	0.46
b2	4.02	4.41
b3	4.00	4.37
c	0.19	0.25
c1	0.17	0.23
c2	0.24	0.30
c3	0.22	0.28
D	4.45	4.70
D1	-	4.45
E	4.95	5.30
E1	3.50	3.70
e	1.27BSC	
H	5.95	6.25
i	-	0.25
L	0.40	0.85
L1	0.27	0.57
L2	0.80	1.30
θ	0°	8°