

## 60V N-Channel Enhancement Mode MOSFET

### 1. Product Information

#### 1.1 Features

- ◇ Surface-mounted package
- ◇ Advanced TRENCH cell design

#### 1.2 Applications

- ◇ LCD TV appliances
- ◇ LCDM appliances
- ◇ High power inverter system

#### 1.3 Quick reference

- ◇  $BV \cong 60\text{ V}$
- ◇  $P_{\text{tot}} \cong 230\text{ W}$
- ◇  $I_D \cong 272\text{ A}$
- ◇  $R_{\text{DS(ON)}} \cong 0.98\text{ m}\Omega @ V_{\text{GS}} = 10\text{ V}$
- ◇  $R_{\text{DS(ON)}} \cong 1.65\text{ m}\Omega @ V_{\text{GS}} = 6\text{ V}$

### 2. Pin Description

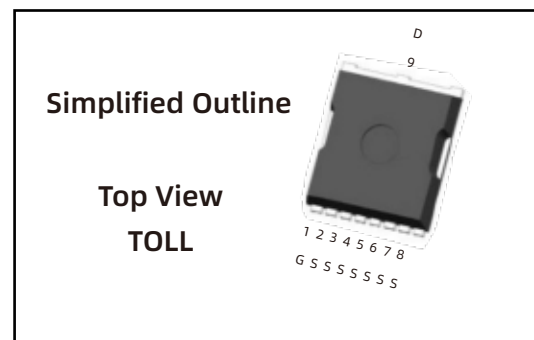
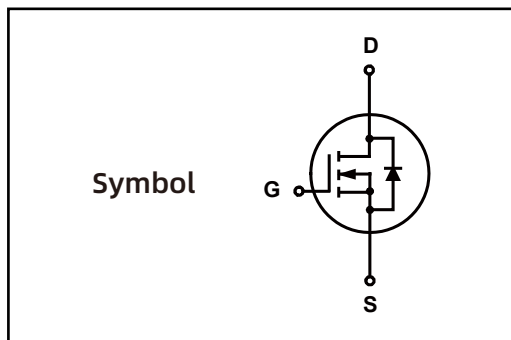

### 3. Marking Information

Product Name	Marking
LNT009N060T	LNT009N060T AYWWZZ XXXXXX

## 4. Limiting Values

Symbol	Parameter	Conditions	Min	Max	Unit
$V_{DS}$	Drain-Source Voltage	$T_C = 25\text{ }^\circ\text{C}$	-	60	V
$V_{GS}$	Gate-Source Voltage	$T_C = 25\text{ }^\circ\text{C}$	-	$\pm 20$	V
$I_D^*$	Drain Current ( DC )	$T_C = 25\text{ }^\circ\text{C}, V_{GS} = 10\text{ V}$	-	272	A
		$T_C = 100\text{ }^\circ\text{C}, V_{GS} = 10\text{ V}$	-	192	A
$I_{DM}^*$	Drain Current ( Pulsed )	$T_C = 25\text{ }^\circ\text{C}, V_{GS} = 10\text{ V}$	-	1088	A
$P_{tot}$	Drain power dissipation	$T_C = 25\text{ }^\circ\text{C}$	-	230	W
$T_{stg}$	Storage Temperature		-55	175	$^\circ\text{C}$
$T_J$	Junction Temperature		-	175	$^\circ\text{C}$
$I_S$	Continuous-Source Current	$T_C = 25\text{ }^\circ\text{C}$	-	272	A
$E_{AS}$	Single Pulsed Avalanche Energy	$V_{DD} = 50\text{ V}, L = 1.0\text{ mH}$	-	3042	mJ
$R_{\theta JA}^{**}$	Thermal Resistance- Junction to Ambient		-	47	$^\circ\text{C/W}$
$R_{\theta JC}^{**}$	Thermal Resistance- Junction to Case		-	0.65	

Notes :

\* Pulse width  $\leq 300\text{ }\mu\text{s}$ , duty cycle  $\leq 2\%$

\*\* Surface Mounted on 1 in<sup>2</sup> pad area,  $t \leq 10\text{ sec}$

\*\*\* Limited by bonding wire

## 5. Ordering Code

Product Name	Package	Reel Size	Tape width	Quantity	Note
LNT009N060T	TOLL-8L			2000	

Note: COMTECH defines " Green " as lead-free ( RoHS compliant ) and halogen free ( Br or Cl does not exceed 900 ppm by weight in homogeneous material and total of Br and Cl does not exceed 1500 ppm by weight; Follow IEC 61249-2-21 and IPC / JEDEC J-STD-020C )

## 6. Electrical Characteristics (TA=25 ° Unless Otherwise Noted )

Symbol	Parameter	Conditions	Min	Typ	Max	Unit
<b>Static Characteristics</b>						
$BV_{DSS}$	Drain-Source Breakdown Voltage	$V_{GS} = 0\text{ V}, I_{DS} = 250\ \mu\text{A}$	60	-	-	V
$V_{GS(th)}$	Gate Threshold Voltage	$V_{DS} = V_{GS}, I_{DS} = 250\ \mu\text{A}$	2	-	4	V
$I_{DSS}$	Drain Leakage Current	$V_{DS} = 48\text{ V}, V_{GS} = 0\text{ V}$	-	-	1	$\mu\text{A}$
$I_{GSS}$	Gate Leakage Current	$V_{GS} = 0\text{ V}, V_{GS} = \pm 20\text{ V}$	-	-	$\pm 100$	nA
$R_{DS(on)}^a$	On-State Resistance	$V_{GS} = 10\text{ V}, I_{DS} = 50\text{ A}$	-	0.9	0.98	m $\Omega$
		$V_{GS} = 6\text{ V}, I_{DS} = 30\text{ A}$	-	1.4	1.65	
<b>Diode Characteristics</b>						
$V_{SD}^a$	Diode Forward Voltage	$I_{SD} = 50\text{ A}, V_{GS} = 0\text{ V}$	-	-	1.3	V
$t_{rr}$	Reverse Recovery Time	$I_{DS} = 50\text{ A}, V_{GS} = 0\text{ V}$	-	31	-	nS
$Q_{rr}$	Reverse Recovery Charge	$dI_{SD}/dt = 100\text{ A}/\mu\text{s}$	-	20	-	nC
<b>Dynamic Characteristics<sup>b</sup></b>						
$C_{ISS}$	Input Capacitance	$V_{GS} = 0\text{ V}, V_{DS} = 30\text{ V}$ Frequency = 1 MHz	-	38092	-	pF
$C_{OSS}$	Output Capacitance		-	1310	-	
$C_{rSS}$	Reverse Transfer Capacitance		-	1075	-	
$t_d(on)$	Turn-on Delay Time	$V_{DS} = 30\text{ V}, V_{GEN} = 10\text{ V},$ $R_G = 3.9\ \Omega, R_L = 0.6\ \Omega,$ $I_{DS} = 50\text{ A}$	-	91	-	nS
$t_r$	Turn-on Rise Time		-	160	-	
$t_d(off)$	Turn-off Delay Time		-	357	-	
$t_f$	Turn-off Fall Time		-	629	-	
<b>Gate Charge Characteristics<sup>b</sup></b>						
$Q_g$	Total Gate Charge	$V_{DS} = 30\text{ V}, V_{GS} = 10\text{ V},$ $I_{DS} = 50\text{ A}$	-	592	-	nC
$Q_{gs}$	Gate-Source Charge		-	196	-	
$Q_{gd}$	Gate-Drain Charge		-	96	-	

Notes :

a : Pulse test ; pulse width  $\leq 300\ \mu\text{s}$ , duty cycle  $\leq 2\%$

b : Guaranteed by design, not subject to production testing

## 7. Typical Characteristics

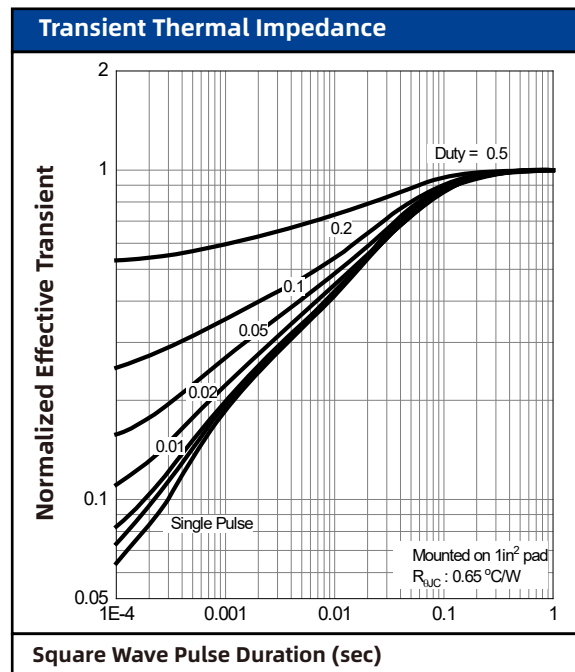
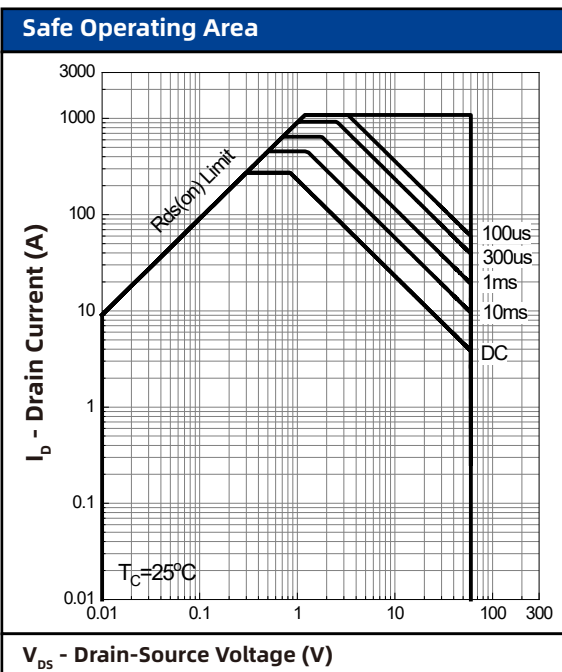
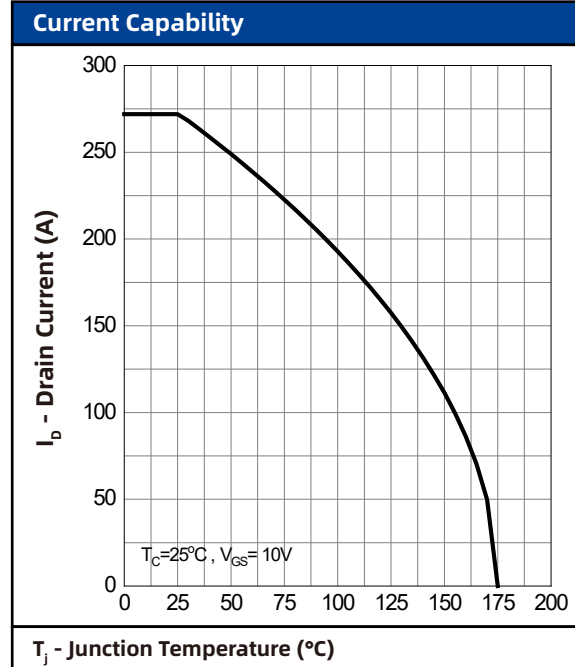
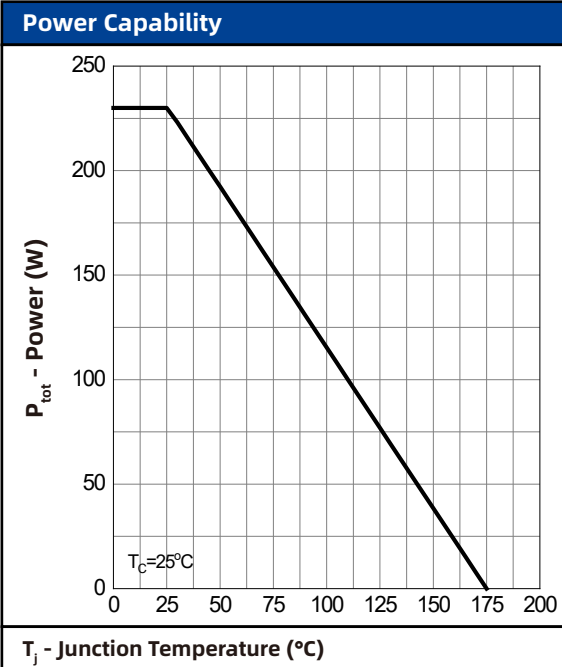

## 7. Typical Characteristics (cont.)

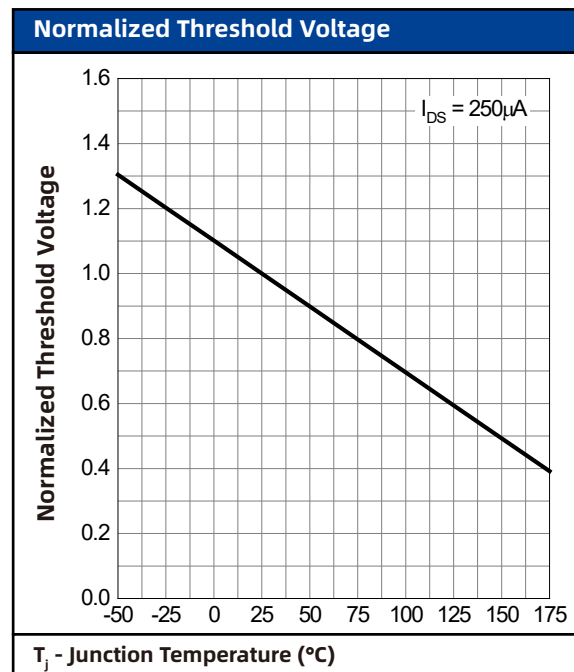
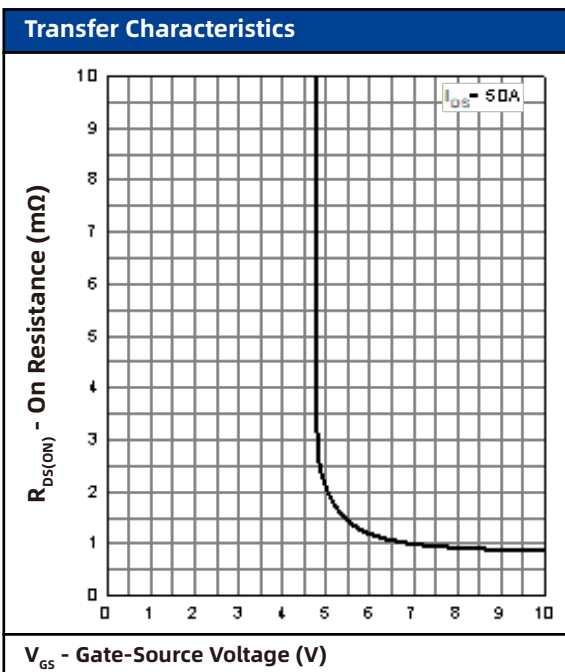
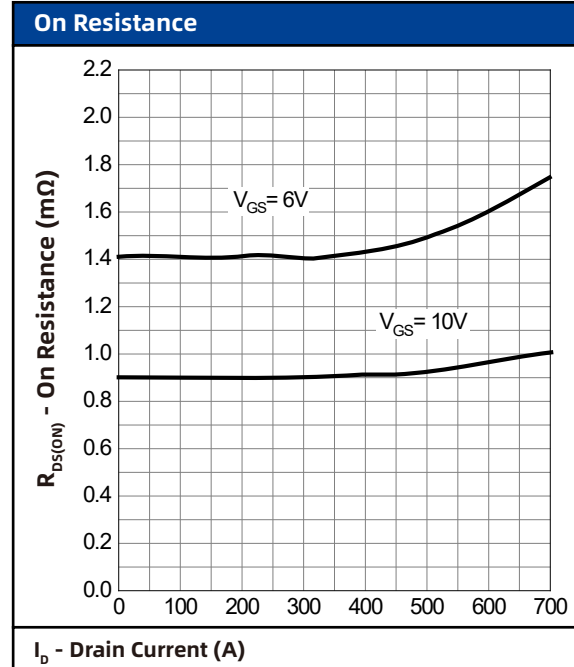
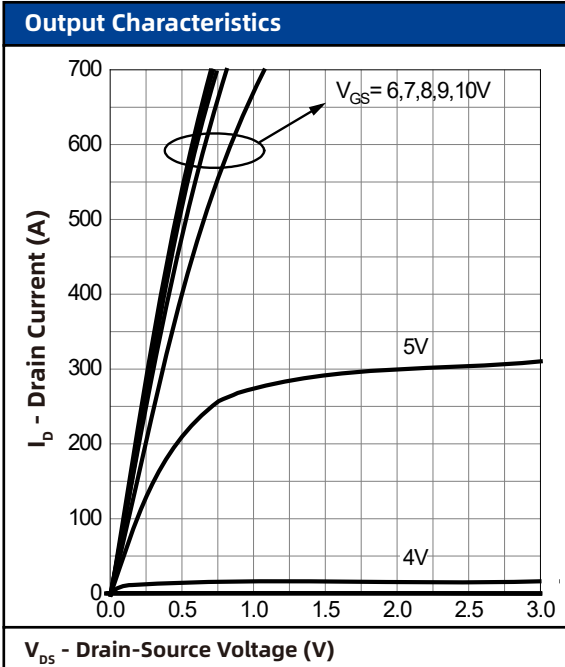

## 7. Typical Characteristics (cont.)

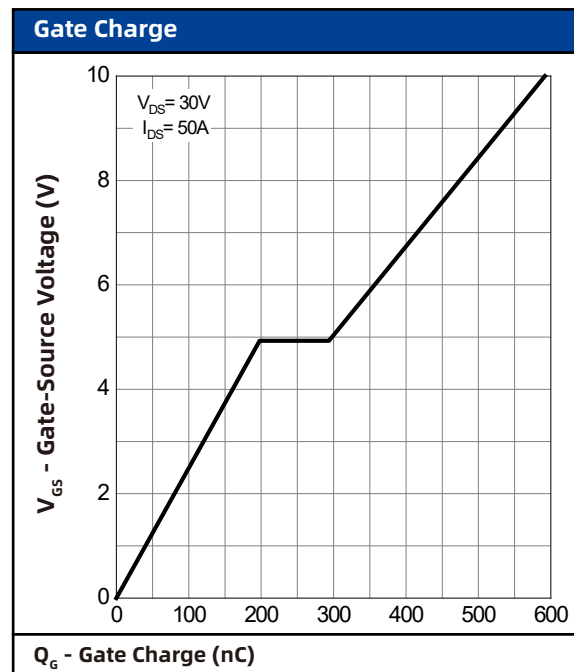
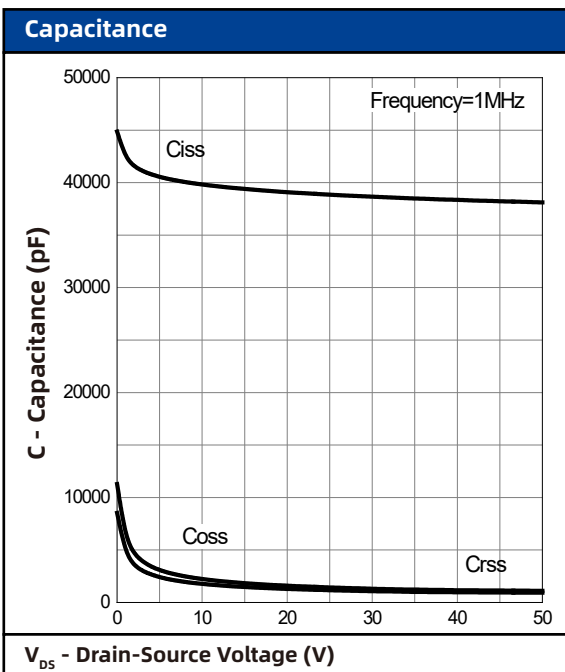
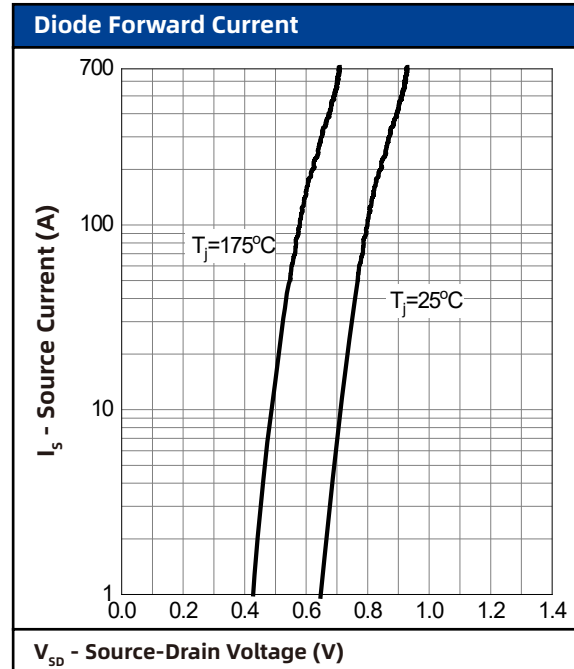
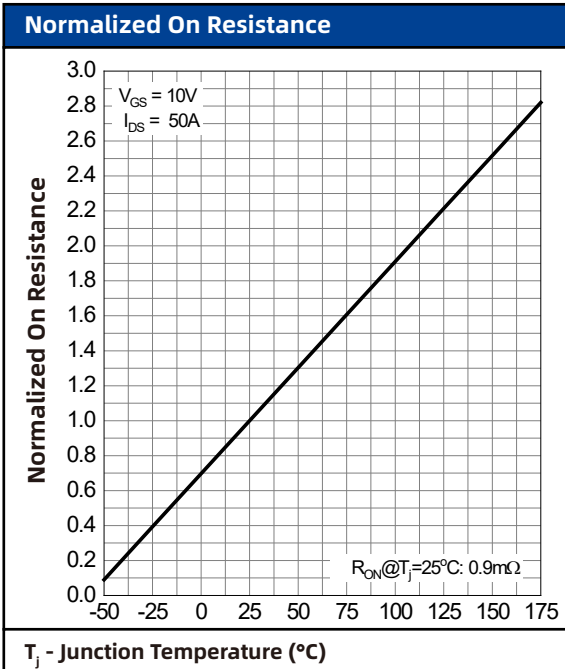

## 8. Package Dimensions

### TOLL-8 Package

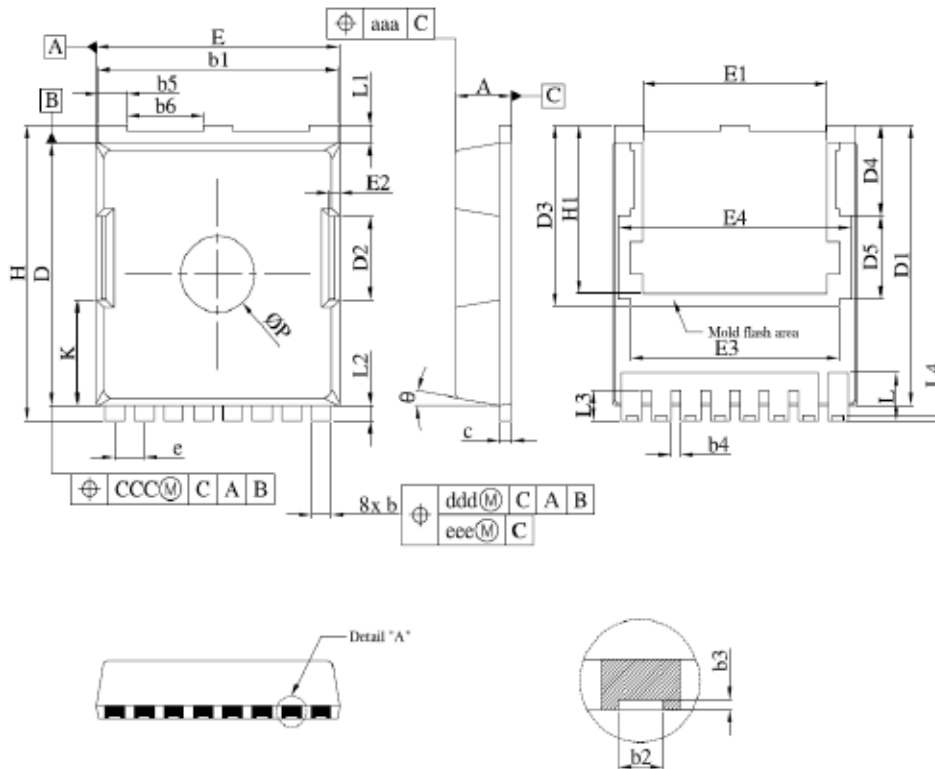

Symbol	Dimensions In Millimeters	
	Min	Max
A	2.20	2.40
b	0.70	0.90
b1	9.70	9.90
b2	0.36	0.55
b3	0.05	/
b4	0.30	0.50
b5	1.10	1.30
b6	3.00	3.20
c	0.40	0.60
D	10.28	10.55
D1	10.98	11.18
D2	3.20	3.40
D3	7.15	
D4	3.59	
D5	3.26	
e	1.10	1.30
E	9.80	10.00
E1	7.40	7.60

Symbol	Dimensions In Millimeters	
	Min	Max
E2	7.40	7.60
E3	8.50	
E4	9.46	
H	11.50	11.85
H1	6.55	6.75
K	4.08	4.28
L	1.60	2.10
L1	0.50	0.90
L2	0.50	0.70
L3	1.00	1.30
L4	0.13	0.33
p	2.85	3.15
θ	10°REF	
aaa	0.20	
ccc	0.20	
ddd	0.25	
eee	0.20	