

## 100V N-Channel Enhancement Mode MOSFET

### 1. Product Information

#### 1.1 Features

- ◇ Surface-mounted package
- ◇ Advanced SGT cell design

#### 1.2 Applications

- ◇ LCD TV appliances
- ◇ High power inverter system
- ◇ LCDM appliances

#### 1.3 Quick reference

- ◇  $BV \cong 100\text{ V}$
- ◇  $P_{\text{tot}} \cong 365\text{ W}$
- ◇  $I_D \cong 180\text{ A}$

- ◇  $R_{\text{DS(ON)}} \cong 2.8\text{m}\Omega @ V_{\text{GS}} = 10\text{ V}$

### 2. Pin Description

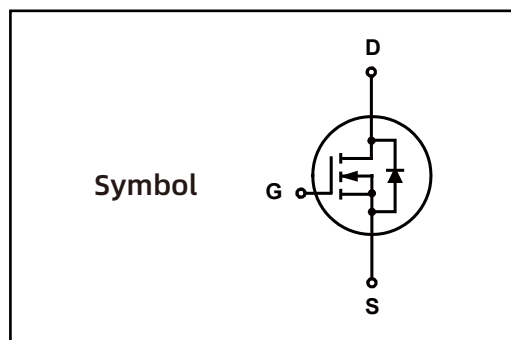

#### Simplified Outline

Top View  
TO-220-3L



### 3. Marking Information

Product Name	Marking
LN025N100C	LN025N100C CYWWZZ XXXXXX

## 4.Limiting Values

Symbol	Parameter	Conditions	Min	Max	Unit
$V_{DS}$	Drain-Source Voltage	$T_C = 25\text{ }^\circ\text{C}$	-	100	V
$V_{GS}$	Gate-Source Voltage	$T_C = 25\text{ }^\circ\text{C}$	-	$\pm 20$	V
$I_D^*$	Drain Current ( DC )	$T_C = 25\text{ }^\circ\text{C}, V_{GS} = 10\text{ V}$	-	180	A
		$T_C = 100\text{ }^\circ\text{C}, V_{GS} = 10\text{ V}$	-	126	A
$I_{DM}^{*,**}$	Drain Current ( Pulsed )	$T_C = 25\text{ }^\circ\text{C}, V_{GS} = 10\text{ V}$	-	1000	A
$P_{tot}$	Drain power dissipation	$T_C = 25\text{ }^\circ\text{C}$	-	365	W
$T_{stg}$	Storage Temperature		- 55	175	$^\circ\text{C}$
$T_J$	Junction Temperature		-	175	$^\circ\text{C}$
$I_S$	Continuous-Source Current	$T_C = 25\text{ }^\circ\text{C}$	-	180	A
$E_{AS}^*$	Single Pulsed Avalanche Energy	$V_{DD} = 50\text{ V}, L = 0.5\text{ mH}, I_{AS} = 56\text{ A}$	-	784	mJ
$R_{\theta JA}^*$	Thermal Resistance- Junction to Ambient		-	62	$^\circ\text{C}/\text{W}$
$R_{\theta JC}$	Thermal Resistance- Junction to Case		-	0.5	

Notes :

\* Surface Mounted on 1 in<sup>2</sup> pad area,  $t \leq 10\text{ sec}$

\*\* Pulse width  $\leq 300\text{ }\mu\text{s}$ , duty cycle  $\leq 2\%$

\*\*\* limited by bonding wire

## 5.Ordering Code

Product Name	Package	Reel Size	Tape width	Quantity	Note
LN025N100C	TO220C			50	

Note: COMTECH defines " Green " as lead-free ( RoHS compliant ) and halogen free ( Br or Cl does not exceed 900 ppm by weight in homogeneous material and total of Br and Cl does not exceed 1500 ppm by weight; Follow IEC 61249-2-21 and IPC / JEDEC J-STD-020C )

## 6. Electrical Characteristics (TA=25 ° Unless Otherwise Noted)

Symbol	Parameter	Conditions	Min	Typ	Max	Unit
<b>Static Characteristics</b>						
$BV_{DSS}$	Drain-Source Breakdown Voltage	$V_{GS} = 0\text{ V}, I_{DS} = 250\ \mu\text{A}$	100	-	-	V
$V_{GS(th)}$	Gate Threshold Voltage	$V_{DS} = V_{GS}, I_{DS} = 250\ \mu\text{A}$	2	-	4	V
$I_{DSS}$	Drain Leakage Current	$V_{DS} = 80\text{ V}, V_{GS} = 0\text{ V}$	-	-	1	$\mu\text{A}$
$I_{GSS}$	Gate Leakage Current	$V_{DS} = 0\text{ V}, V_{GS} = \pm 20\text{ V}$	-	-	$\pm 100$	nA
$R_{DS(on)}^a$	On-State Resistance	$V_{GS} = 10\text{ V}, I_{DS} = 50\text{ A}$	-	2.5	2.8	m $\Omega$
<b>Diode Characteristics</b>						
$V_{SD}^a$	Diode Forward Voltage	$I_{SD} = 50\text{ A}, V_{GS} = 0\text{ V}$	-	-	1.3	V
$t_{rr}$	Reverse Recovery Time	$I_{DS} = 50\text{ A}, V_{GS} = 0\text{ V}$	-	97	-	nS
$Q_{rr}$	Reverse Recovery Charge	$dI_{SD}/dt = 100\text{ A}/\mu\text{s}$	-	138	-	nC
<b>Dynamic Characteristics<sup>b</sup></b>						
$C_{ISS}$	Input Capacitance	$V_{GS} = 0\text{ V}, V_{DS} = 50\text{ V}$ Frequency = 1 MHz	-	9200	-	pF
$C_{OSS}$	Output Capacitance		-	1130	-	
$C_{rSS}$	Reverse Transfer Capacitance		-	110	-	
$t_d(on)$	Turn-on Delay Time	$V_{DS} = 50\text{ V}, V_{GEN} = 10\text{ V},$ $R_G = 3.9\ \Omega, R_L = 1\ \Omega,$ $I_{DS} = 50\text{ A}$	-	32	-	nS
$t_r$	Turn-on Rise Time		-	40	-	
$t_d(off)$	Turn-off Delay Time		-	80	-	
$t_f$	Turn-off Fall Time		-	35	-	
<b>Gate Charge Characteristics<sup>b</sup></b>						
$Q_g$	Total Gate Charge	$V_{DS} = 50\text{ V}, V_{GS} = 10\text{ V},$ $I_{DS} = 50\text{ A}$	-	131	-	nC
$Q_{gs}$	Gate-Source Charge		-	50	-	
$Q_{gd}$	Gate-Drain Charge		-	24	-	

Notes :

a : Pulse test ; pulse width  $\leq 300\ \mu\text{s}$ , duty cycle  $\leq 2\%$

b : Guaranteed by design, not subject to production testing

## 7. Typical Characteristics

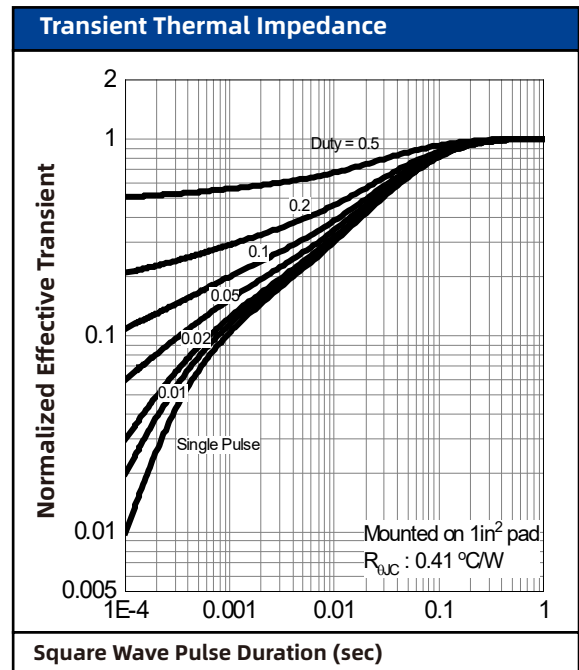
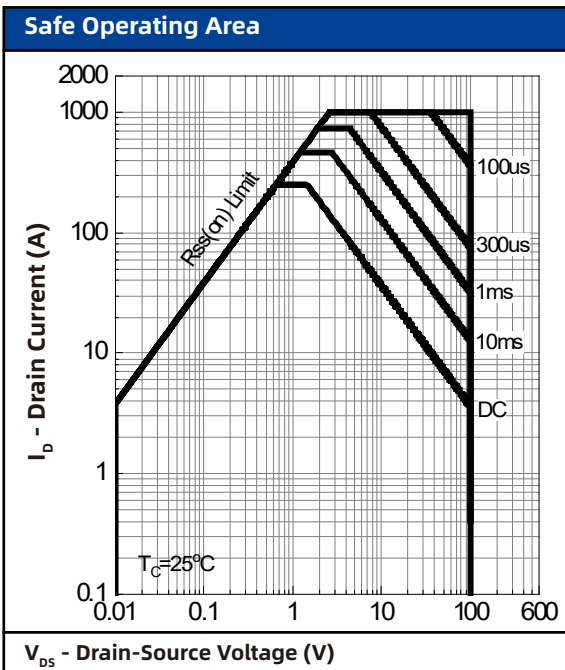
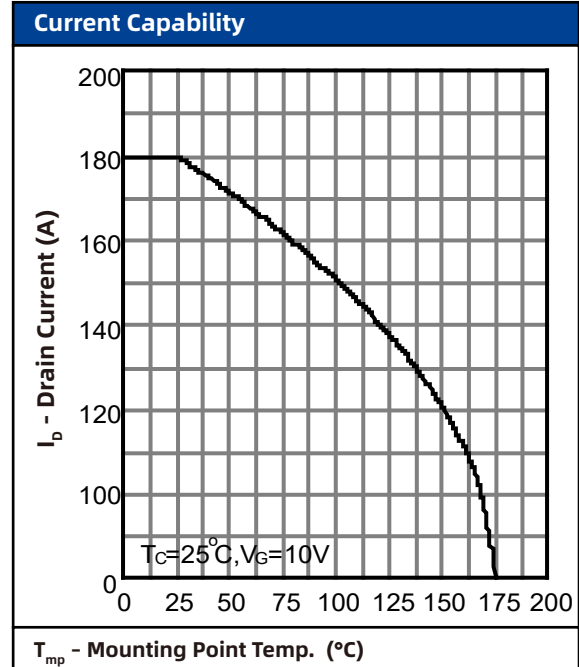
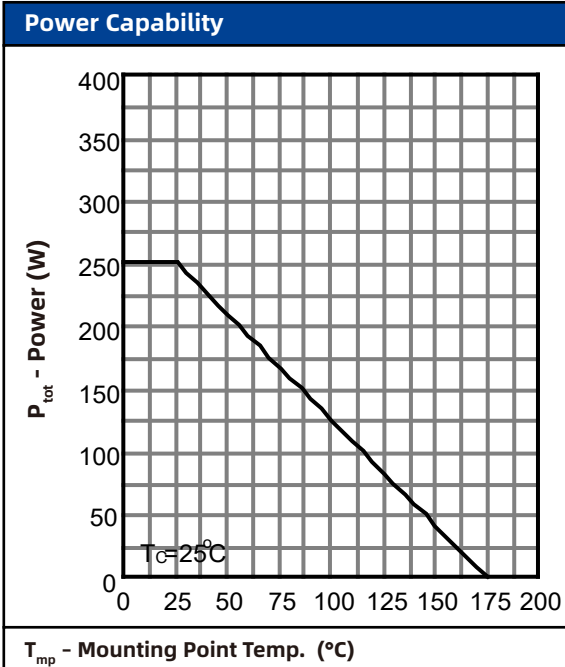

## 7. Typical Characteristics (cont.)

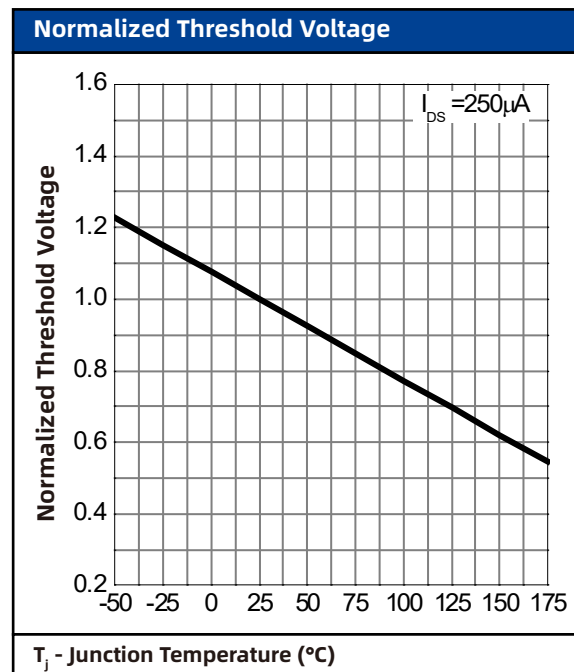
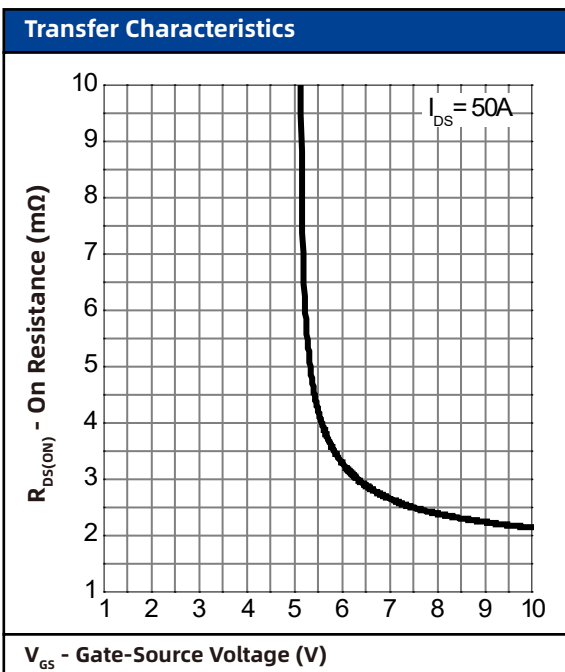
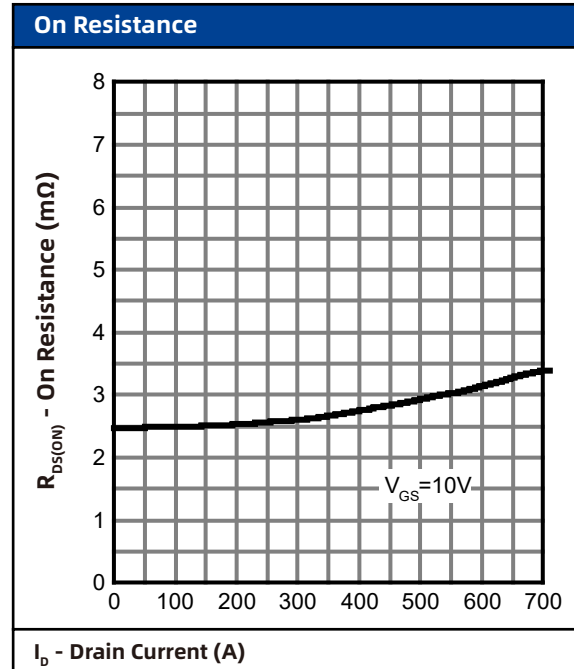
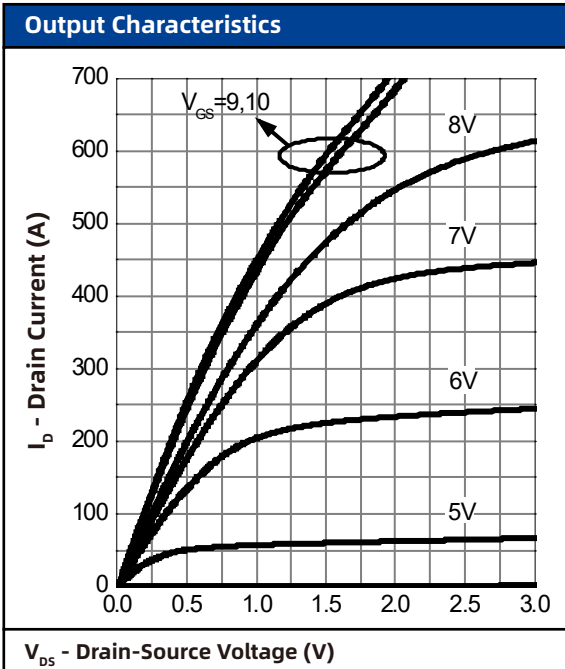

## 7. Typical Characteristics (cont.)

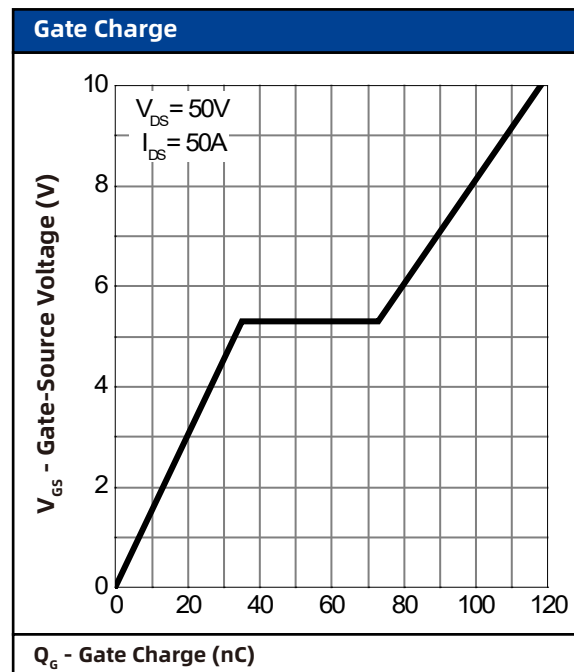
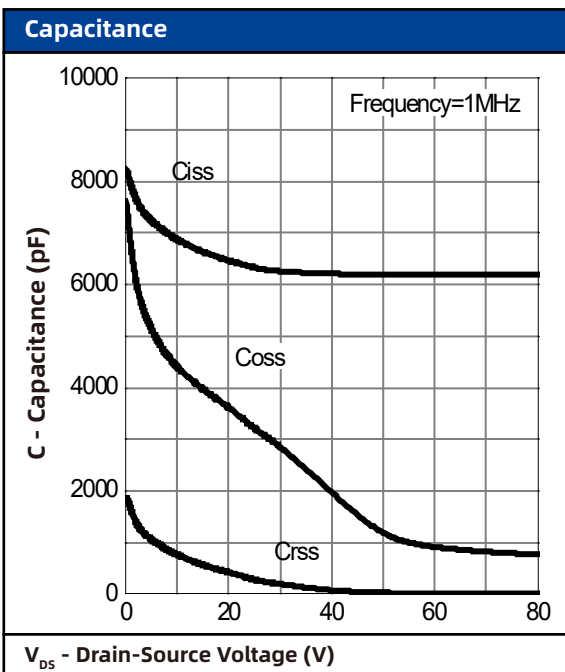
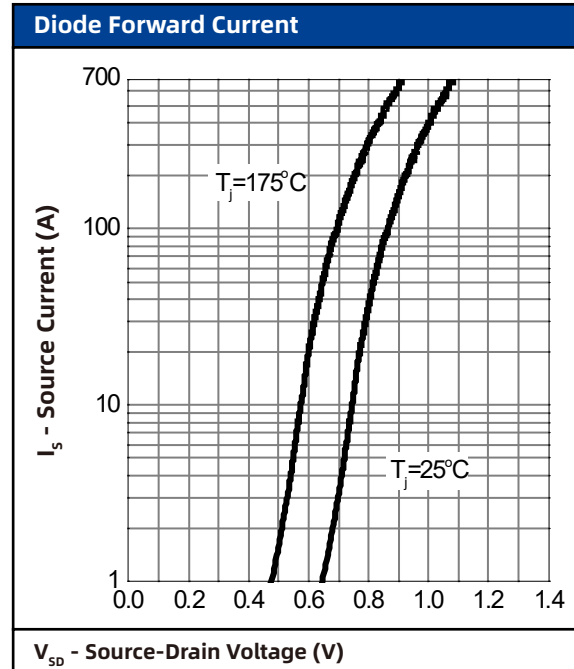
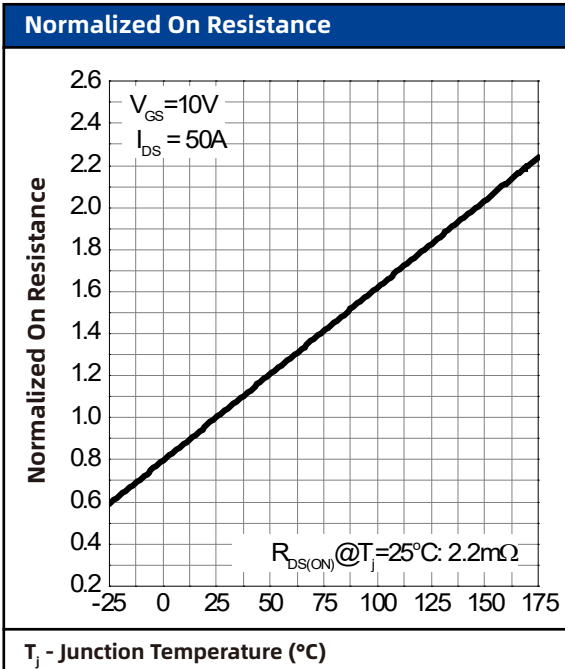

## 8. Package Dimensions

### TO-220-3L

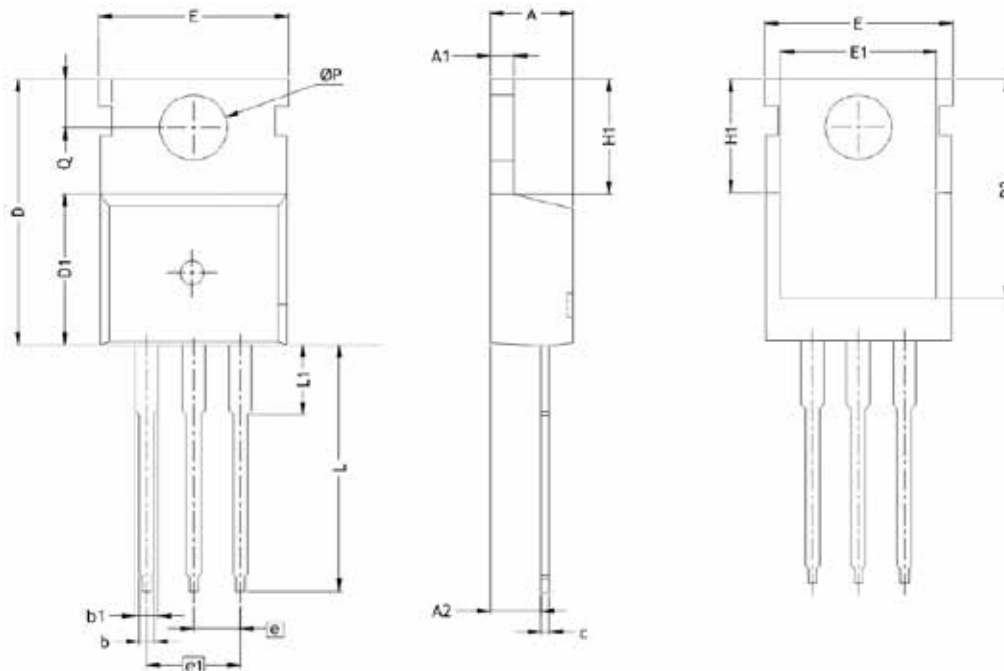

Symbol	Dimensions In Millimeters	
	MIN.	MAX.
A	4.25	4.65
A1	1.25	1.35
A2	2.35	2.55
b	0.7	0.9
b1	1.15	1.75
c	0.45	0.61
D	14.35	16.51
D1	8.58	9.50
D2	13.05	13.65
E	9.90	10.50
E1	7.85	8.89
e	2.54BSC	
e1	5.08BSC	
H1	6.30	6.65
L	12.85	13.50
L1	2.85	3.25
ΦP	3.53	4.09
Q	2.70	2.93