

## 60V N-Channel Enhancement Mode MOSFET

### 1. Product Information

#### 1.1 Features

- ◇ Advanced SGT cell design
- ◇ Low Thermal Resistance
- ◇ MSL1

#### 1.2 Applications

- ◇ Motor drivers
- ◇ DC-DC Converter

#### 1.3 Quick reference

- ◇  $BV \cong 60\text{ V}$
- ◇  $P_{\text{tot}} \cong 125\text{ W}$
- ◇  $I_D \cong 167\text{ A}$
- ◇  $R_{\text{DS(ON)}} \cong 2.0\text{ m}\Omega @ V_{\text{GS}} = 10\text{ V}$
- ◇  $R_{\text{DS(ON)}} \cong 3.8\text{ m}\Omega @ V_{\text{GS}} = 6\text{ V}$

### 2. Pin Description

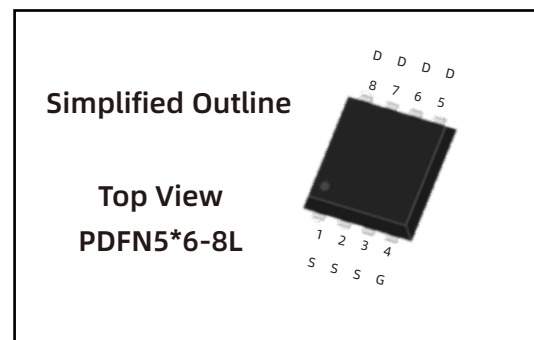
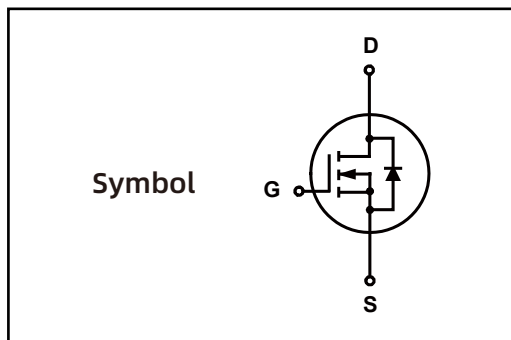

### 3. Marking Information

Product Name	Marking
LN014N060G-H	LN014N060G-H CYWWZZ XXXXXX

## 4.Limiting Values

Symbol	Parameter	Conditions	Min	Max	Unit
$V_{DS}$	Drain-Source Voltage	$T_C = 25\text{ }^\circ\text{C}$	-	60	V
$V_{GS}$	Gate-Source Voltage	$T_C = 25\text{ }^\circ\text{C}$	-	$\pm 20$	V
$I_D^*$	Drain Current ( DC )	$T_C = 25\text{ }^\circ\text{C}, V_{GS} = 10\text{ V}$	-	167	A
		$T_C = 100\text{ }^\circ\text{C}, V_{GS} = 10\text{ V}$	-	118	A
$I_{DM}^{**}$	Drain Current ( Pulsed )	$T_C = 25\text{ }^\circ\text{C}, V_{GS} = 10\text{ V}$	-	600	A
$P_{tot}^*$	Total Power Dissipation	$T_C = 25\text{ }^\circ\text{C}$	-	125	W
$T_{stg}$	Storage Temperature		-55	175	$^\circ\text{C}$
$T_J$	Junction Temperature		-	175	$^\circ\text{C}$
$I_S$	Diode Forward Current	$T_C = 25\text{ }^\circ\text{C}$	-	167	A
$E_{AS}^*$	Single Pulsed Avalanche Energy	$V_{DD} = 50\text{ V}, L = 1.0\text{ mH}$	-	760	mJ
$R_{\theta JA}^*$	Thermal Resistance- Junction to Ambient		-	57	$^\circ\text{C}/\text{W}$
$R_{\theta JC}$	Thermal Resistance- Junction to Case		-	1.2	

Notes :

- \* Surface Mounted on 1 in<sup>2</sup> pad area,  $t \leq 10\text{ sec}$
- \*\* Pulse width  $\leq 300\text{ }\mu\text{s}$ , duty cycle  $\leq 2\%$

## 5.Ordering Code

Product Name	Package	Reel Size	Tape width	Quantity	Note
LN014N060G-H	PDFN5*6			5000	

Note: COMTECH defines " Green " as lead-free ( RoHS compliant ) and halogen free ( Br or Cl does not exceed 900 ppm by weight in homogeneous material and total of Br and Cl does not exceed 1500 ppm by weight;

Follow IEC 61249-2-21 and IPC / JEDEC J-STD-020C )

## 6. Electrical Characteristics ( $T_A=25^\circ$ Unless Otherwise Noted )

Symbol	Parameter	Conditions	Min	Typ	Max	Unit
<b>Static Characteristics</b>						
$BV_{DSS}$	Drain-Source Breakdown Voltage	$V_{GS} = 0\text{ V}, I_{DS} = 250\ \mu\text{A}$	60	-	-	V
$V_{GS(th)}$	Gate Threshold Voltage	$V_{DS} = 0\text{ V}, I_{DS} = 250\ \mu\text{A}$	2	-	4	V
$I_{DSS}$	Drain Leakage Current	$V_{DS} = 48\text{ V}, V_{GS} = 0\text{ V}$	-	-	1	$\mu\text{A}$
$I_{GSS}$	Gate Leakage Current	$V_{GS} = 0\text{ V}, V_{GS} = \pm 20\text{ V}$	-	-	$\pm 100$	nA
$R_{DS(on)}^a$	On-State Resistance	$V_{GS} = 10\text{ V}, I_{DS} = 50\text{ A}$	-	1.8	2.0	m $\Omega$
		$V_{GS} = 6\text{ V}, I_{DS} = 30\text{ A}$	-	3.2	3.8	
<b>Diode Characteristics</b>						
$V_{SD}^a$	Diode Forward Voltage	$I_{SD} = 50\text{ A}, V_{GS} = 0\text{ V}$	-	-	1.3	V
$t_{rr}$	Reverse Recovery Time	$I_{SD} = 50\text{ A}, V_{GS} = 0\text{ V}$	-	72	-	nS
$Q_{rr}$	Reverse Recovery Charge	$di_{SD}/dt = 100\text{ A}/\mu\text{s}$	-	42	-	nC
<b>Dynamic Characteristics<sup>b</sup></b>						
$C_{ISS}$	Input Capacitance	$V_{GS} = 0\text{ V}, V_{DS} = 30\text{ V}$ Frequency = 1 MHz	-	4589	-	pF
$C_{OSS}$	Output Capacitance		-	1594	-	
$C_{rSS}$	Reverse Transfer Capacitance		-	64	-	
$t_d(on)$	Turn-on Delay Time	$V_{DS} = 30\text{ V}, V_{GEN} = 10\text{ V},$ $R_G = 3.9\ \Omega, R_L = 0.6\ \Omega,$ $I_{DS} = 50\text{ A}$	-	19	-	nS
$t_r$	Turn-on Rise Time		-	81	-	
$t_d(off)$	Turn-off Delay Time		-	43	-	
$t_f$	Turn-off Fall Time		-	28	-	
<b>Gate Charge Characteristics<sup>b</sup></b>						
$Q_g$	Total Gate Charge	$V_{DS} = 30\text{ V}, V_{GS} = 10\text{ V},$ $I_{DS} = 50\text{ A}$	-	76	-	nC
$Q_{gs}$	Gate-Source Charge		-	27	-	
$Q_{gd}$	Gate-Drain Charge		-	18	-	

Notes :

a : Pulse test ; pulse width  $\leq 300\ \mu\text{s}$ , duty cycle  $\leq 2\%$

b : Guaranteed by design, not subject to production testing

## 7. Typical Characteristics

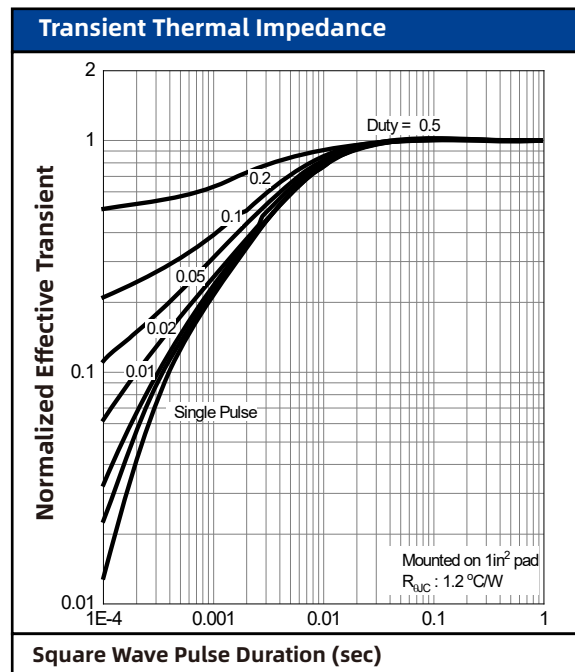
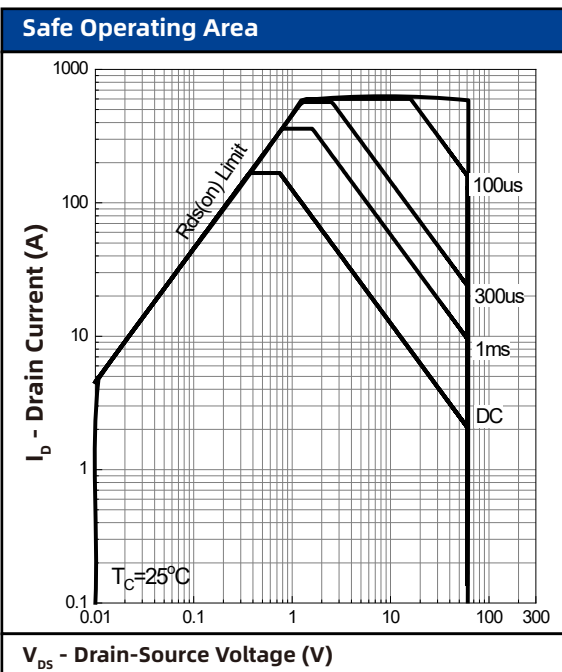
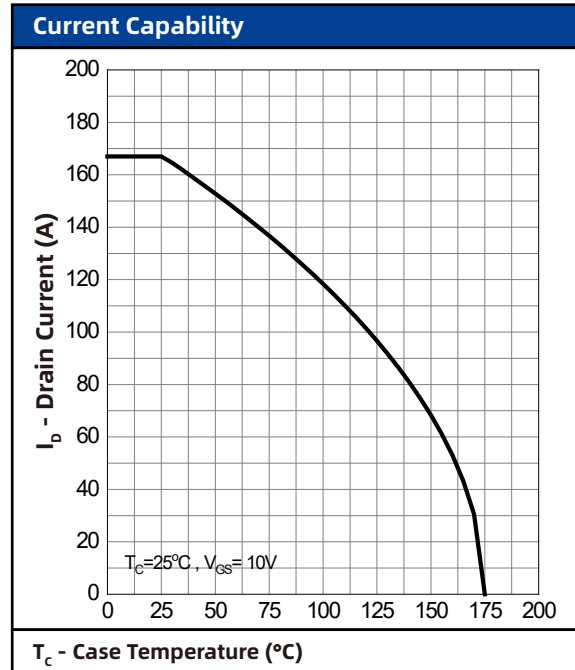
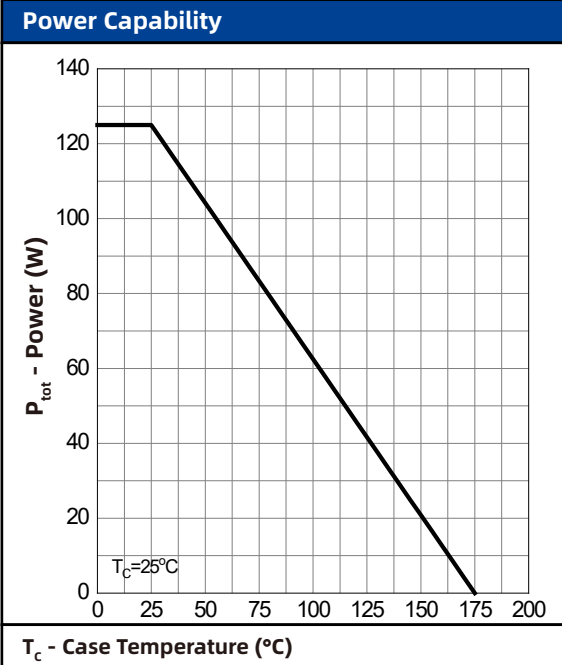

## 7. Typical Characteristics (cont.)

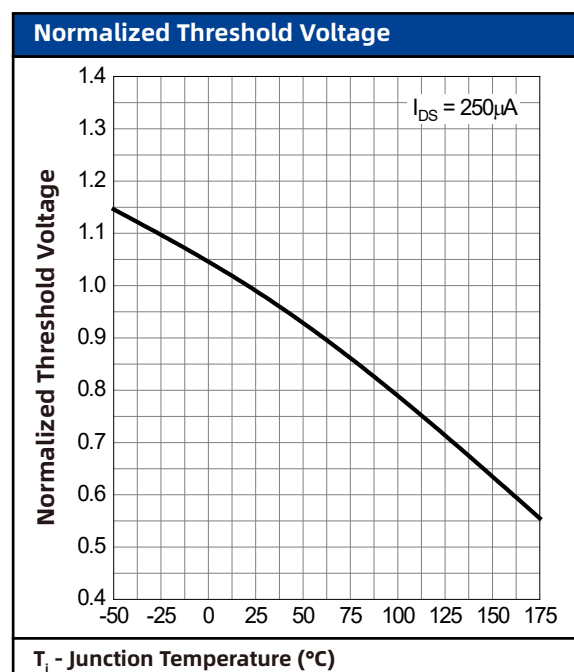
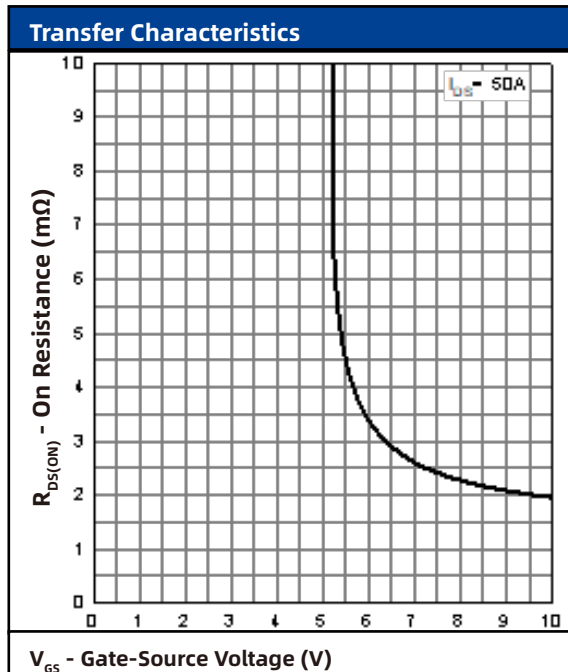
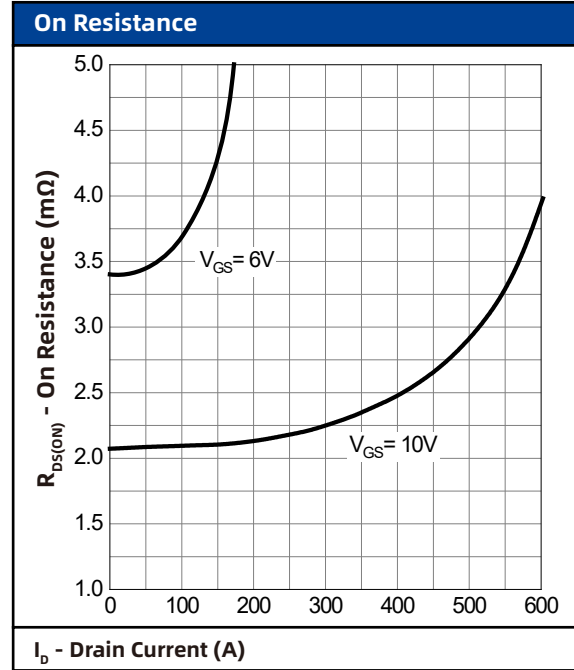
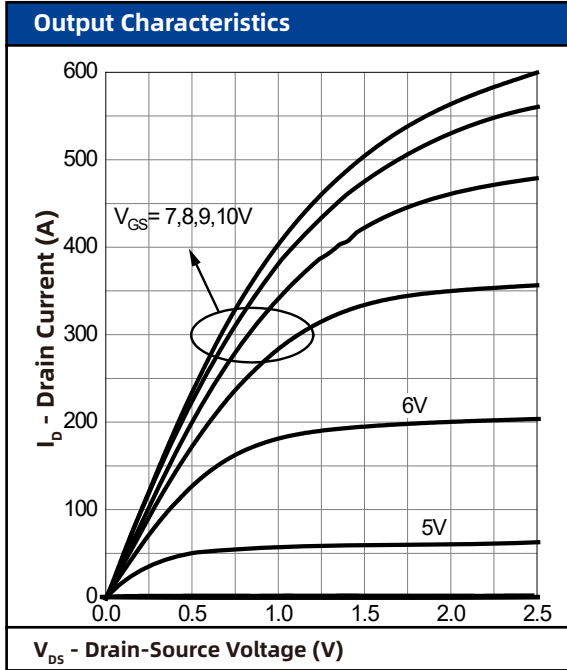

## 7. Typical Characteristics (cont.)

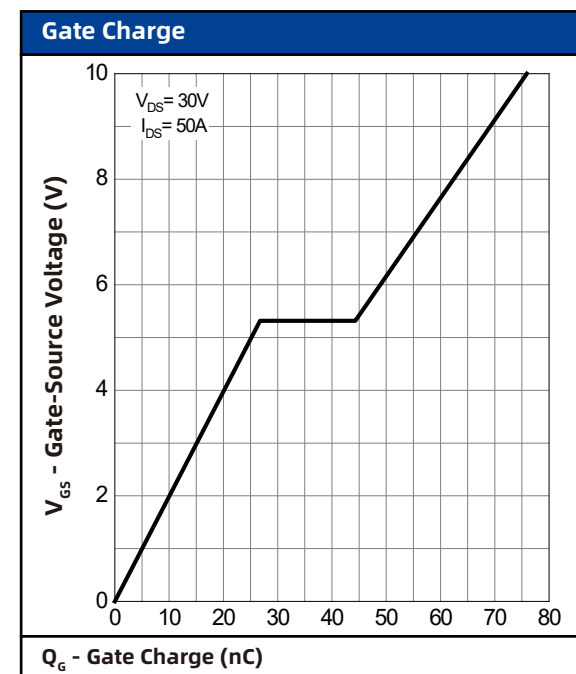
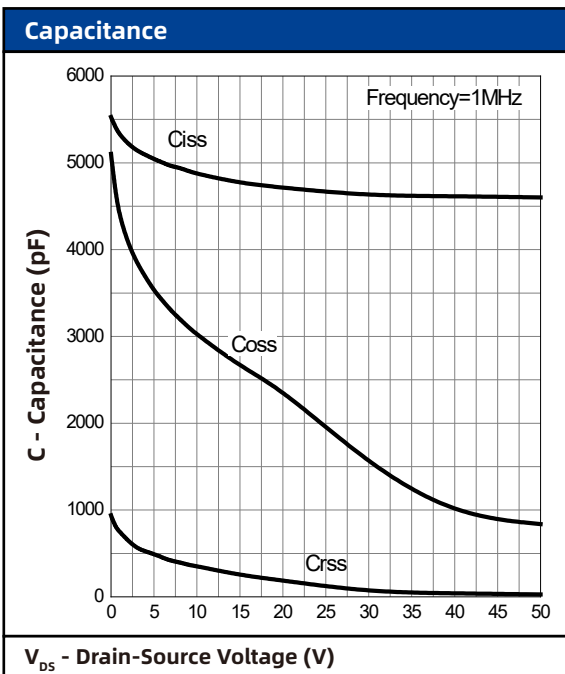
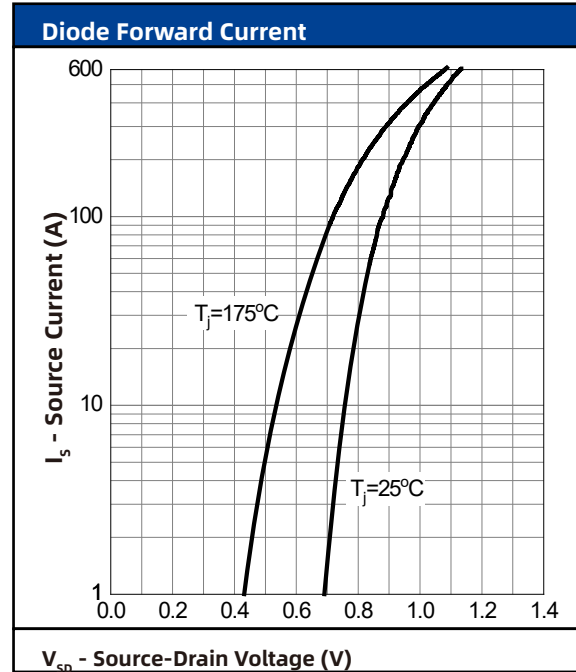
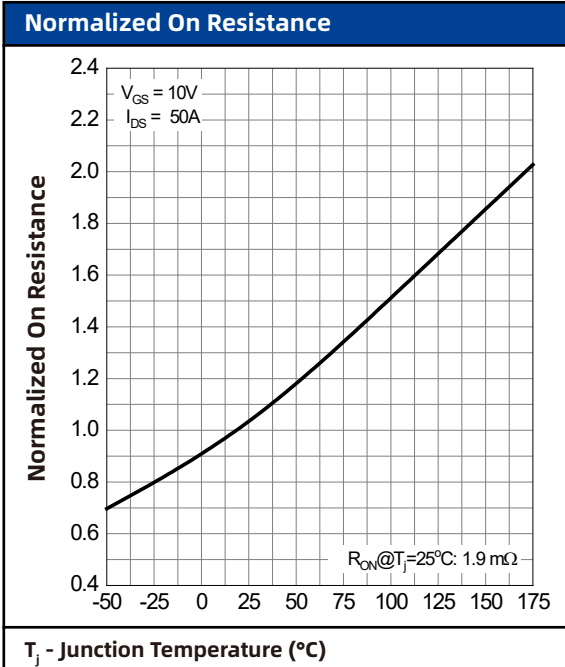

## 8. Package Dimensions

### PDFN5\*6-8L Package

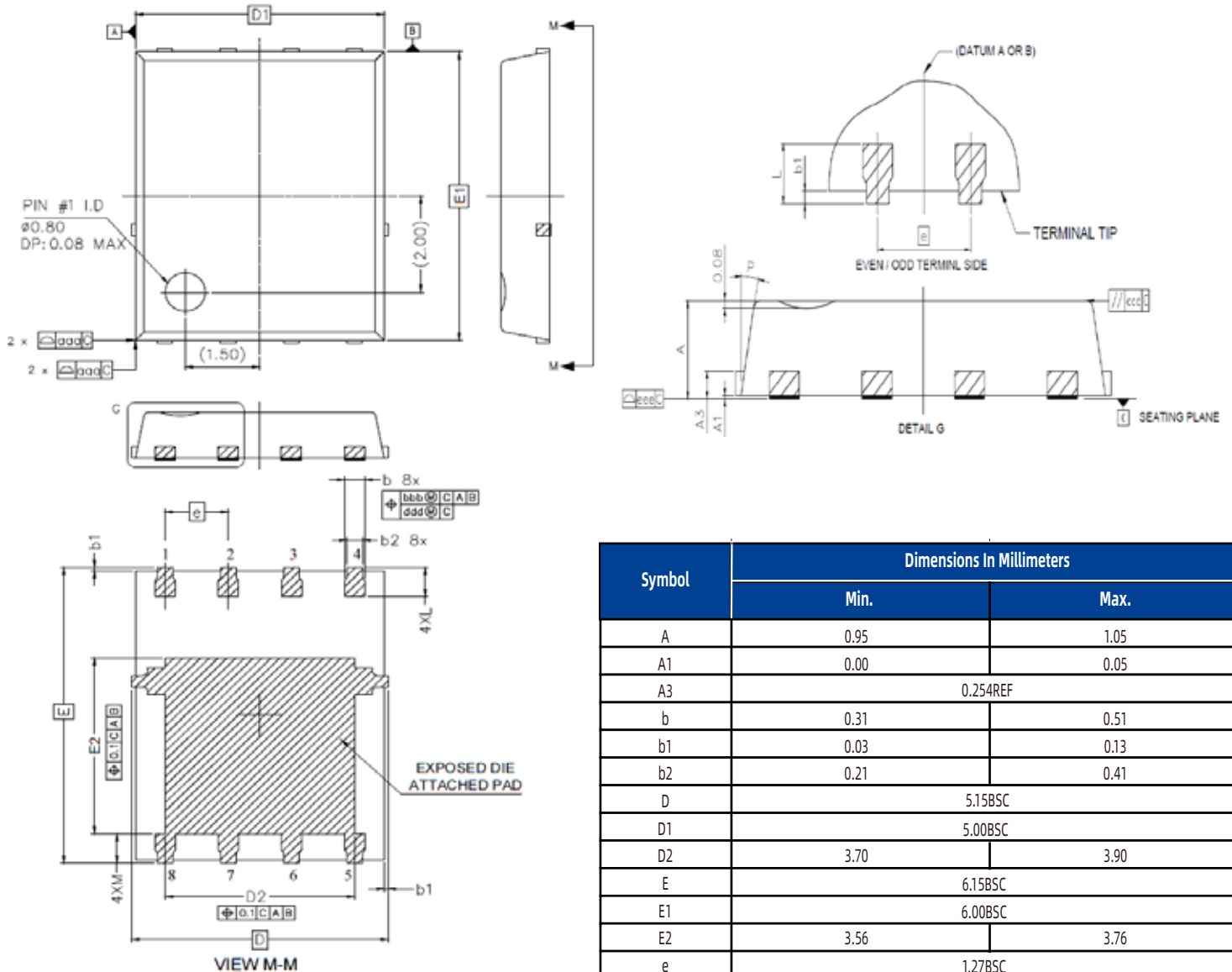

Symbol	Dimensions In Millimeters	
	Min.	Max.
A	0.95	1.05
A1	0.00	0.05
A3	0.254REF	
b	0.31	0.51
b1	0.03	0.13
b2	0.21	0.41
D	5.15BSC	
D1	5.00BSC	
D2	3.70	3.90
E	6.15BSC	
E1	6.00BSC	
E2	3.56	3.76
e	1.27BSC	
L	0.51	0.71
M	0.51	0.71
p	10°	12°
aaa	0.10	
bbb	0.10	
ccc	0.10	
ddd	0.05	
eee	0.08	