

## 60V P-Channel Enhancement Mode MOSFET

### 1. Product Information

#### 1.1 Features

- ◇ Advanced TRENCH cell design
- ◇ Low Thermal Resistance

#### 1.2 Applications

- ◇ Motor drivers
- ◇ DC-DC Converter

#### 1.3 Quick reference

- ◇  $BV \cong -60\text{ V}$
- ◇  $P_{\text{tot}} \cong 35\text{ W}$
- ◇  $I_D \cong -100\text{ A}$
- ◇  $R_{\text{DS(ON)}} \cong 6.5\text{m}\Omega @ V_{\text{GS}} = -10\text{ V}$
- ◇  $R_{\text{DS(ON)}} \cong 8.5\text{m}\Omega @ V_{\text{GS}} = -4.5\text{ V}$

### 2. Pin Description

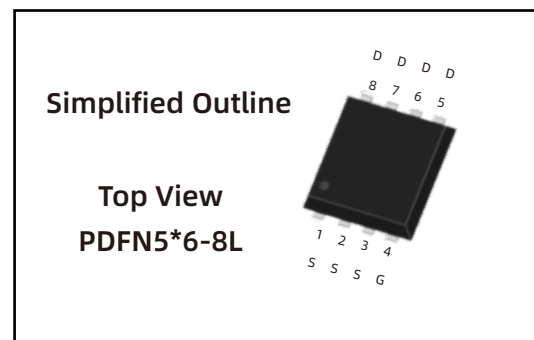

### 3. Marking Information

Product Name	Marking
LN055P060G	LN055P060G CYWWZZ XXXXXX

## 4.Limiting Values

Symbol	Parameter	Conditions	Min	Max	Unit
$V_{DS}$	Drain-Source Voltage	$T_C = 25\text{ }^\circ\text{C}$	-60	-	V
$V_{GS}$	Gate-Source Voltage	$T_C = 25\text{ }^\circ\text{C}$	-	$\pm 20$	V
$I_D^*$	Drain Current ( DC )	$T_C = 25\text{ }^\circ\text{C}, V_{GS} = -10\text{ V}$	-	- 100	A
		$T_C = 100\text{ }^\circ\text{C}, V_{GS} = -10\text{ V}$	-	- 57	A
$I_{DM}^{*,**}$	Drain Current ( Pulsed )	$T_C = 25\text{ }^\circ\text{C}, V_{GS} = -10\text{ V}$	-	- 232	A
$P_{tot}^*$	Total Power Dissipation	$T_C = 25\text{ }^\circ\text{C}$	-	35	W
$T_{stg}$	Storage Temperature		-55	150	$^\circ\text{C}$
$T_J$	Junction Temperature		-	150	$^\circ\text{C}$
$I_S$	Diode Forward Current	$T_C = 25\text{ }^\circ\text{C}$	-	- 100	A
$E_{AS}^*$	Single Pulsed Avalanche Energy	$V_{DD} = -50\text{ V}, L = 1.0\text{ mH}$	-	392	mJ
$R_{\theta JA}^*$	Thermal Resistance- Junction to Ambient		-	43	$^\circ\text{C}/\text{W}$
$R_{\theta JC}^*$	Thermal Resistance- Junction to Case		-	1.3	

Notes :

\* Surface Mounted on 1 in<sup>2</sup> pad area,  $t \leq 10\text{ sec}$

\*\* Pulse width  $\leq 300\text{ }\mu\text{s}$ , duty cycle  $\leq 2\%$

\*\*\* Limited by bonding wire

## 5.Ordering Code

Product Name	Package	Reel Size	Tape width	Quantity	Note
LN055P060G	PDFN5*6			5000	

Note: COMTECH defines " Green " as lead-free ( RoHS compliant ) and halogen free ( Br or Cl does not exceed 900 ppm by weight in homogeneous material and total of Br and Cl does not exceed 1500 ppm by weight; Follow IEC 61249-2-21 and IPC / JEDEC J-STD-020C )

## 6. Electrical Characteristics ( $T_A=25^\circ$ Unless Otherwise Noted )

Symbol	Parameter	Conditions	Min	Typ	Max	Unit
<b>Static Characteristics</b>						
$BV_{DSS}$	Drain-Source Breakdown Voltage	$V_{GS} = 0\text{ V}, I_D = -250\ \mu\text{A}$	-60	-	-	V
$V_{GS(th)}$	Gate Threshold Voltage	$V_{DS} = V_{GS}, I_{DS} = -250\ \mu\text{A}$	-1	-	-2	V
$I_{DSS}$	Zero Gate Voltage Source Current	$V_{DS} = -48\text{ V}, V_{GS} = 0\text{ V}$	-	-	-1	$\mu\text{A}$
$I_{GSS}$	Gate Leakage Current	$V_{GS} = \pm 20\text{ V}, V_{DS} = 0\text{ V}$	-	-	$\pm 100$	nA
$R_{DS(on)}^a$	Drain-Source On-State Resistance	$V_{GS} = -10\text{ V}, I_{DS} = -20\text{ A}$	-	5.5	6.5	m $\Omega$
		$V_{GS} = -4.5\text{ V}, I_D = -10\text{ A}$	-	7.0	8.5	
<b>Diode Characteristics</b>						
$V_{SD}^a$	Diode Forward Voltage	$I_{SD} = -20\text{ A}, V_{GS} = 0\text{ V}$	-	-	-1.2	V
$t_{rr}$	Reverse Recovery Time	$I_{SD} = -20\text{ A}$	-	34	-	nS
$Q_{rr}$	Reverse Recovery Charge	$dI_{SD}/dt = 100\text{ A}/\mu\text{s}$	-	36	-	nC
<b>Dynamic Characteristics<sup>b</sup></b>						
$C_{ISS}$	Input Capacitance	$V_{GS} = 0\text{ V}, V_{DS} = -30\text{ V}$ Frequency = 1 MHz	-	12542	-	pF
$C_{OSS}$	Output Capacitance		-	656	-	
$C_{rSS}$	Reverse Transfer Capacitance		-	192	-	
$t_d(on)$	Turn-on Delay Time	$V_{DS} = -30\text{ V}, V_{GEN} = -10\text{ V},$ $R_G = 3.9\ \Omega, R_L = 1.5\ \Omega,$ $I_{DS} = -20\text{ A}$	-	165	-	nS
$t_r$	Turn-on Rise Time		-	220	-	
$t_d(off)$	Turn-off Delay Time		-	1492	-	
$t_f$	Turn-off Fall Time		-	614	-	
<b>Gate Charge Characteristics<sup>b</sup></b>						
$Q_g$	Total Gate Charge	$V_{DS} = -30\text{ V}, V_{GS} = -10\text{ V},$ $I_{DS} = -20\text{ A}$	-	222	-	nC
$Q_{gs}$	Gate-Source Charge		-	45	-	
$Q_{gd}$	Gate-Drain Charge		-	35	-	

Notes :

a : Pulse test ; pulse width  $\leq 300\ \mu\text{s}$ , duty cycle  $\leq 2\%$

b : Guaranteed by design, not subject to production testing

## 7. Typical Characteristics

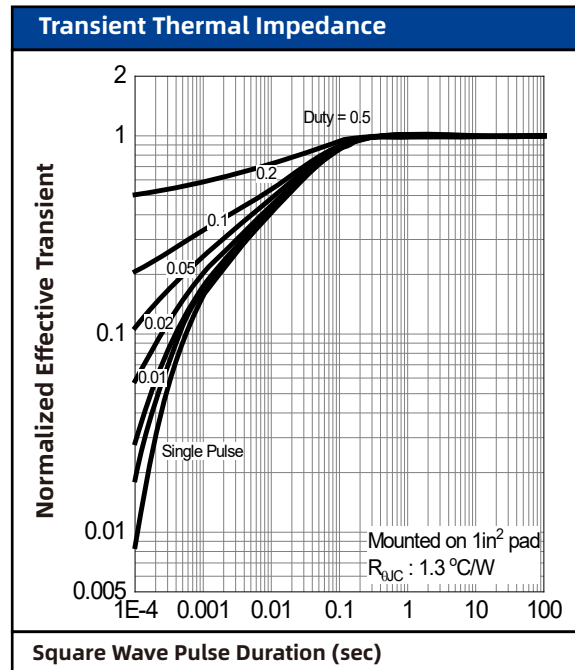
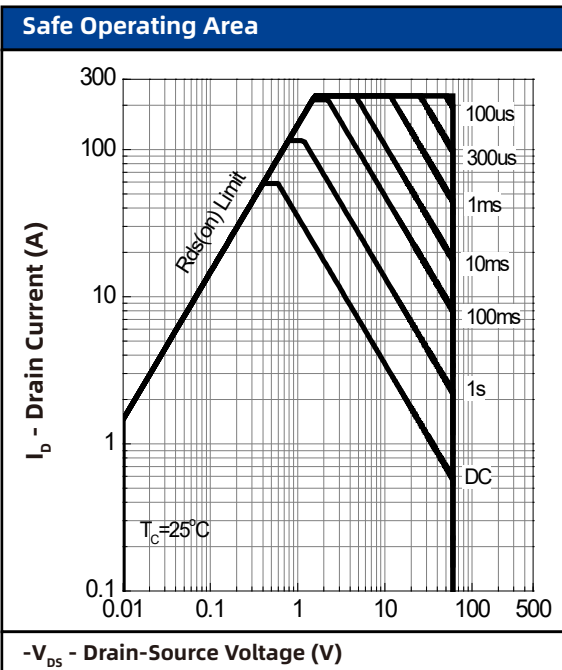
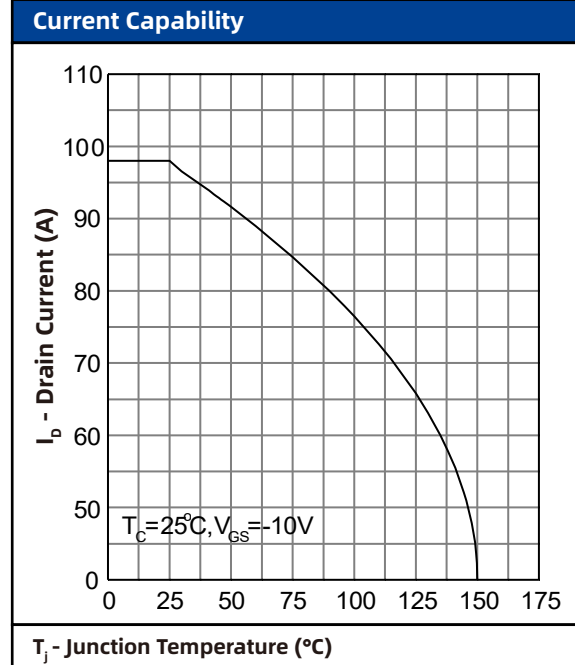
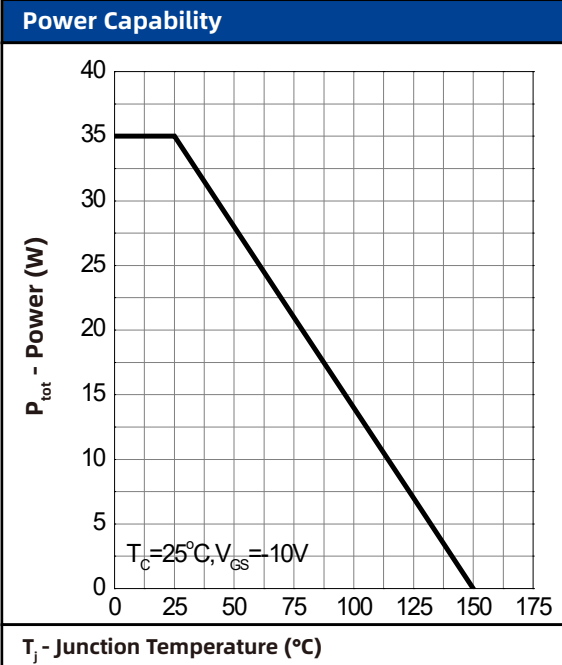

## 7. Typical Characteristics (cont.)

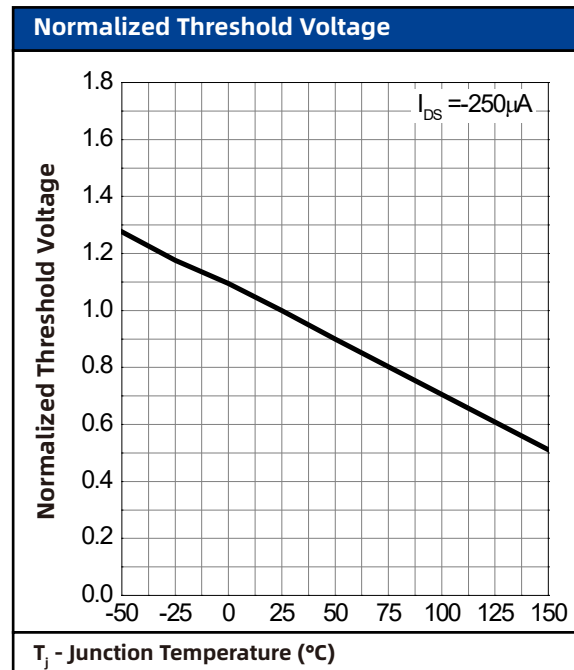
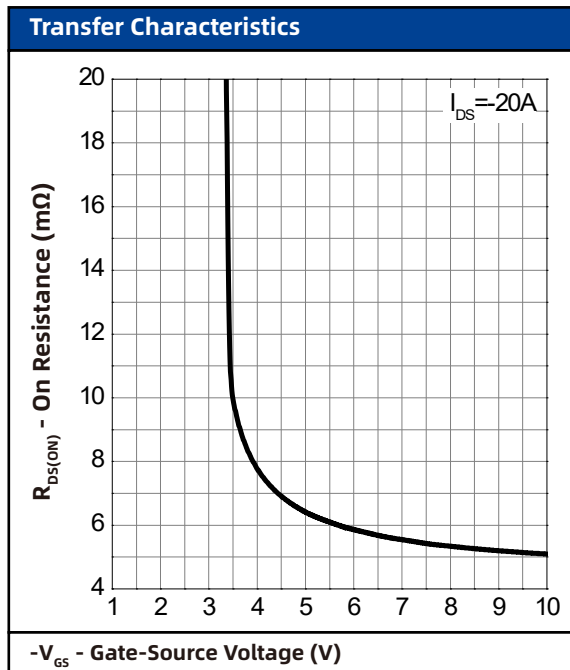
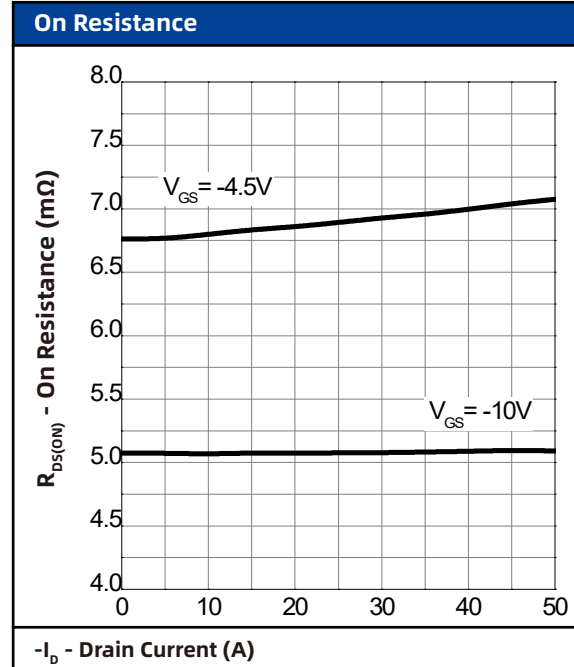
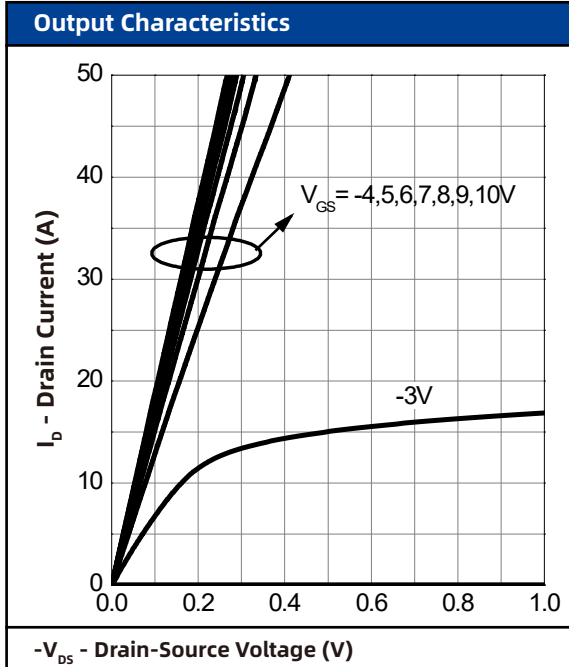

## 7. Typical Characteristics (cont.)

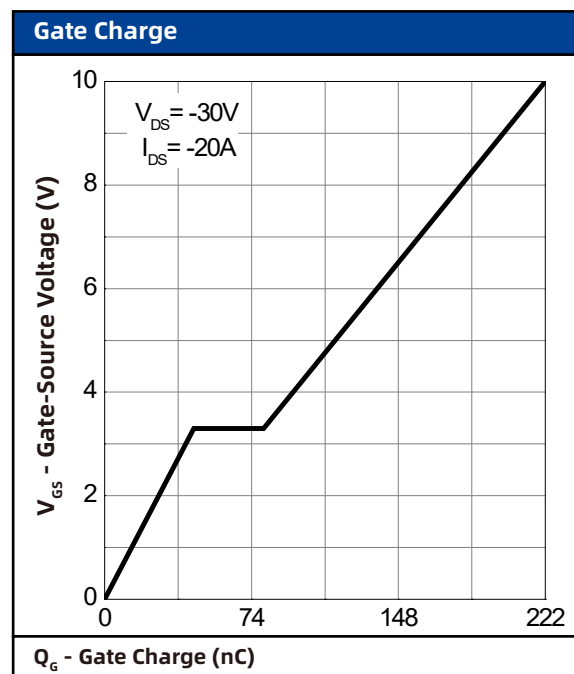
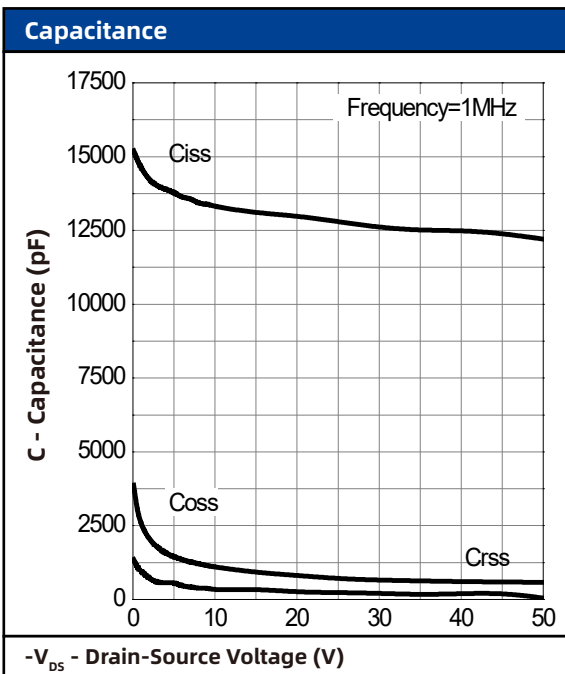
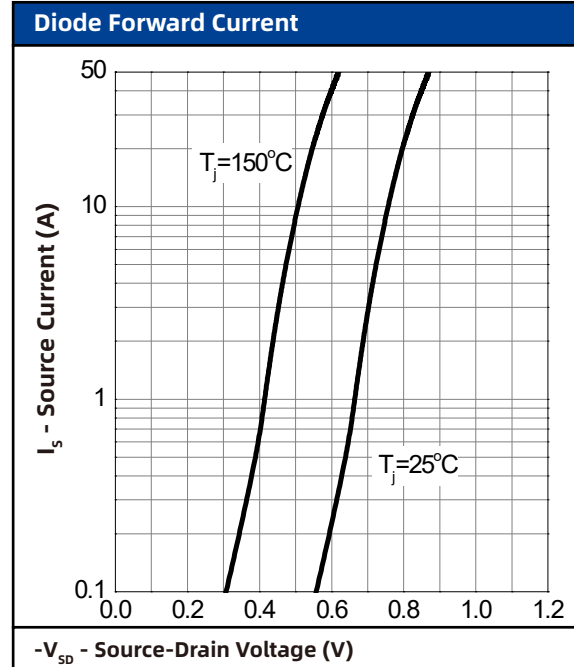
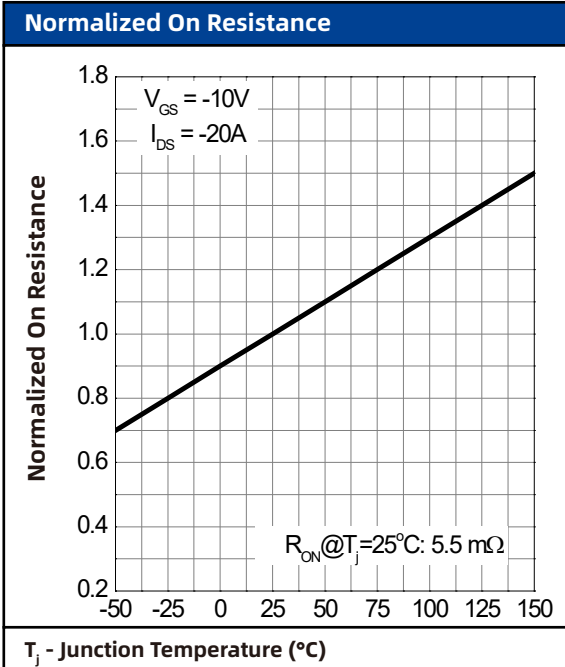

## 8. Package Dimensions

### PDFN5\*6-8L Package

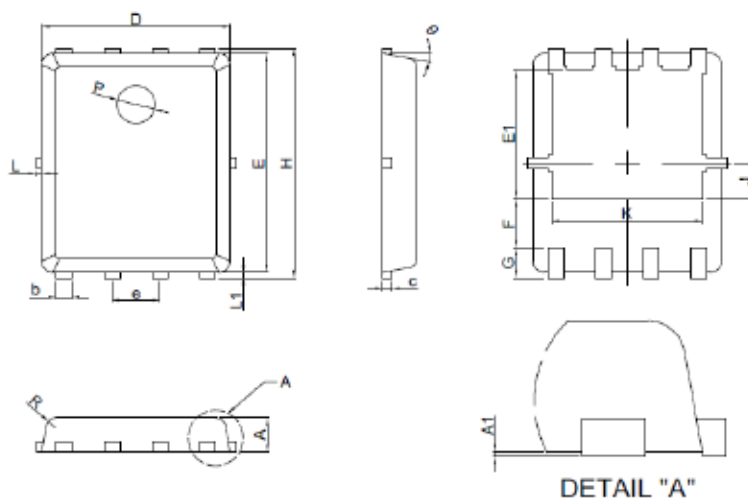

Symbol	Dimensions In Millimeters	
	Min.	Max.
A	0.80	1.00
A1	0.00	0.05
b	0.35	0.49
c	0.254REF	
D	4.90	5.10
F	1.40REF	
E	5.70	5.90
e	1.27BSC	
H	5.95	6.20
L1	0.10	0.18
G	0.60REF	
K	4.00REF	
L	-	0.15
J	0.95BSC	
P	1.00REF	
E1	3.40REF	
θ	6°	14°
R	0.25REF	